

## **AXIS T90B Series**

**AXIS T90B15 W-LED**

**AXIS T90B25 W-LED**

**AXIS T90B35 W-LED**

**AXIS T90B20 IR-LED**

**AXIS T90B30 IR-LED**

**AXIS T90B40 IR-LED**

## **Installation Guide**

## Legal Considerations

Video and audio surveillance can be regulated by laws that vary from country to country. Check the laws in your local region before using this product for surveillance purposes.

## Liability

Every care has been taken in the preparation of this document. Please inform your local Axis office of any inaccuracies or omissions. Axis Communications AB cannot be held responsible for any technical or typographical errors and reserves the right to make changes to the product and manuals without prior notice. Axis Communications AB makes no warranty of any kind with regard to the material contained within this document, including, but not limited to, the implied warranties of merchantability and fitness for a particular purpose. Axis Communications AB shall not be liable nor responsible for incidental or consequential damages in connection with the furnishing, performance or use of this material. This product is only to be used for its intended purpose.

## Intellectual Property Rights

Axis AB has intellectual property rights relating to technology embodied in the product described in this document. In particular, and without limitation, these intellectual property rights may include one or more of the patents listed at [www.axis.com/patent.htm](http://www.axis.com/patent.htm) and one or more additional patents or pending patent applications in the US and other countries.

## Equipment Modifications

This equipment must be installed and used in strict accordance with the instructions given in the user documentation. This equipment contains no user-serviceable components. Unauthorized equipment changes or modifications will invalidate all applicable regulatory certifications and approvals.

## Trademark Acknowledgments

AXIS COMMUNICATIONS, AXIS, ETRAX, ARTPEC and VAPIX are registered trademarks or trademark applications of Axis AB in various jurisdictions. All other company names and products are trademarks or registered trademarks of their respective companies.

## Regulatory Information

### Europe



This product complies with the applicable CE marking directives and harmonized standards:

- Electromagnetic Compatibility (EMC) Directive 2004/108/EC. See *Electromagnetic Compatibility (EMC) on page 2*.
- Low Voltage (LVD) Directive 2006/95/EC. See *Safety on page 3*.
- Restrictions of Hazardous Substances (RoHS) Directive 2011/65/EU. See *Disposal and Recycling on page 3*.

A copy of the original declaration of conformity may be obtained from Axis Communications AB. See *Contact Information on page 3*.

## Electromagnetic Compatibility (EMC)

This equipment has been designed and tested to fulfill applicable standards for:

- Radio frequency emission when installed according to the instructions and used in its intended environment.
- Immunity to electrical and electromagnetic phenomena when installed according to the instructions and used in its intended environment.

### USA

This equipment has been tested using a shielded network cable (STP) and found to comply with the limits for a Class B digital device, pursuant to part 15 of the FCC Rules. These limits are designed to provide reasonable protection against harmful interference in a residential installation. This equipment generates, uses and can radiate radio frequency energy and, if not installed and used in accordance with the instructions, may cause harmful interference to radio communications. However, there is no guarantee that interference will not occur in a particular installation. If this equipment does cause harmful interference to radio or television reception, which can be determined by turning the equipment off and on, the user is encouraged to try to correct the interference by one or more of the following measures:

- Reorient or relocate the receiving antenna.
- Increase the separation between the equipment and receiver.
- Connect the equipment into an outlet on a circuit different from that to which the receiver is connected.
- Consult the dealer or an experienced radio/TV technician for help.

The product shall be connected using a shielded network cable (STP) that is properly grounded.

### Canada

This Class B digital apparatus complies with Canadian ICES-003. The product shall be connected using a shielded network cable (STP) that is properly grounded.

Cet appareil numérique de la classe B est conforme à la norme NMB-003 du Canada. Le produit doit être connecté à l'aide d'un câble réseau blindé (STP) qui est correctement mis à la terre.

### Europe

This digital equipment fulfills the requirements for RF emission according to the Class B limit of EN 55022. The product shall be connected using a shielded network cable (STP) that is properly grounded.

This product fulfills the requirements for immunity according to EN 61000-6-1 residential, commercial and light-industrial environments.

This product fulfills the requirements for immunity according to EN 61000-6-2 industrial environments.

## Australia/New Zealand

This digital equipment fulfills the requirements for RF emission according to the Class B limit of AS/NZS CISPR 22. The product shall be connected using a shielded network cable (STP) that is properly grounded.

## Korea

이 기기는 가정용(B급) 전자파적합기기로서 주로 가정에서 사용하는 것을 목적으로 하며, 모든 지역에서 사용할 수 있습니다. 적절히 접지된 STP (shielded twisted pair) 케이블을 사용하여 제품을 연결 하십시오.

## Safety

This product complies with EN 60598-1 Luminaire - General requirements and tests.

## Photobiological Safety

This product fulfills the requirements for photobiological safety according to IEC/EN 62471 (risk group 2).

## Disposal and Recycling

When this product has reached the end of its useful life, dispose of it according to local laws and regulations. For information about your nearest designated collection point, contact your local authority responsible for waste disposal. In accordance with local legislation, penalties may be applicable for incorrect disposal of this waste.

## Europe



■ This symbol means that the product shall not be disposed of together with household or commercial waste. Directive 2012/19/EU on waste electrical and electronic equipment (WEEE) is applicable in the European Union member states. To prevent potential harm to human health and the environment, the product must be disposed of in an approved and environmentally safe recycling process. For information about your nearest designated collection point, contact your local authority responsible for waste disposal. Businesses should contact the product supplier for information about how to dispose of this product correctly.

This product complies with the requirements of Directive 2011/65/EU on the restriction of the use of certain hazardous substances in electrical and electronic equipment (RoHS).

## China



This product complies with the requirements of the legislative act Administration on the Control of Pollution Caused by Electronic Information Products (ACPEIP).

## Contact Information

Axis Communications AB  
Emdalavägen 14

223 69 Lund  
Sweden

Tel: +46 46 272 18 00

Fax: +46 46 13 61 30

[www.axis.com](http://www.axis.com)

## Support

Should you require any technical assistance, please contact your Axis reseller. If your questions cannot be answered immediately, your reseller will forward your queries through the appropriate channels to ensure a rapid response. If you are connected to the Internet, you can:

- download user documentation and software updates
- find answers to resolved problems in the FAQ database. Search by product, category, or phrase
- report problems to Axis support staff by logging in to your private support area
- chat with Axis support staff (selected countries only)
- visit Axis Support at [www.axis.com/techsup/](http://www.axis.com/techsup/)

## Learn More!

Visit Axis learning center [www.axis.com/academy/](http://www.axis.com/academy/) for useful trainings, webinars, tutorials and guides.



## Safety Information

Read through this Installation Guide carefully before installing the product. Keep the Installation Guide for future reference.

### Hazard Levels

**▲ DANGER**

Indicates a hazardous situation which, if not avoided, will result in death or serious injury.

**▲ WARNING**

Indicates a hazardous situation which, if not avoided, could result in death or serious injury.

**▲ CAUTION**

Indicates a hazardous situation which, if not avoided, could result in minor or moderate injury.

**NOTICE**

Indicates a situation which, if not avoided, could result in damage to property.

### Other Message Levels

Important

Indicates significant information which is essential for the product to function correctly.

Note

Indicates useful information which helps in getting the most out of the product.

## Safety Instructions

### **▲WARNING**

- The Axis product shall be installed by a trained professional.

### **NOTICE**

- The Axis product shall be used in compliance with local laws and regulations.
- Store the Axis product in a dry and ventilated environment.
- Avoid exposing the Axis product to shocks or heavy pressure.
- Do not install the product on unstable brackets, surfaces or walls.
- Use only applicable tools when installing the Axis product. Excessive force could cause damage to the product.
- Do not use chemicals, caustic agents, or aerosol cleaners. Use a clean cloth dampened with pure water for cleaning.
- Use only accessories that comply with technical specification of the product. These can be provided by Axis or a third party.
- Use only spare parts provided by or recommended by Axis.
- Do not attempt to repair the product by yourself. Contact Axis support or your Axis reseller for service matters.

## Transportation

### **NOTICE**

- When transporting the Axis product, use the original packaging or equivalent to prevent damage to the product.

## Installation Guide

This Installation Guide provides instructions for installing AXIS T90B Series.

### Installation Steps

1. Make sure the package contents, tools and other materials necessary for the installation are in order. See *page 7*.
2. Study the hardware overview. See *page 8*.
3. Study the specifications. See *page 14*.
4. Install the hardware. See *page 15*.

### Package Contents

- AXIS T90B Illuminator including power cable
- 1 pre-mounted diverging lens
- 2 separate diverging lenses

### Optional Accessories

- Mounting brackets
- Remote control
- Diverging lens with additional angle
- Power supply

For information about available accessories, see [www.axis.com](http://www.axis.com)

## Hardware Overview

### Illuminator

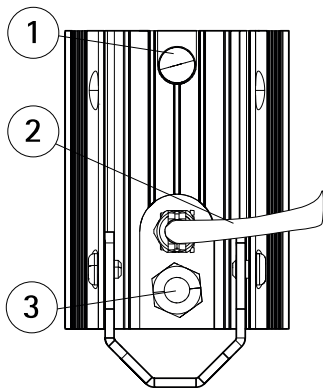
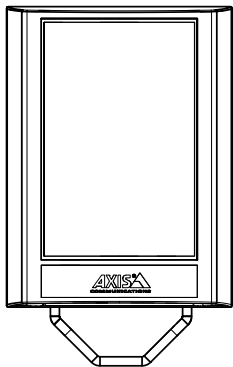

- 1 *Photocell*
- 2 *Cable*
- 3 *Breather gland*



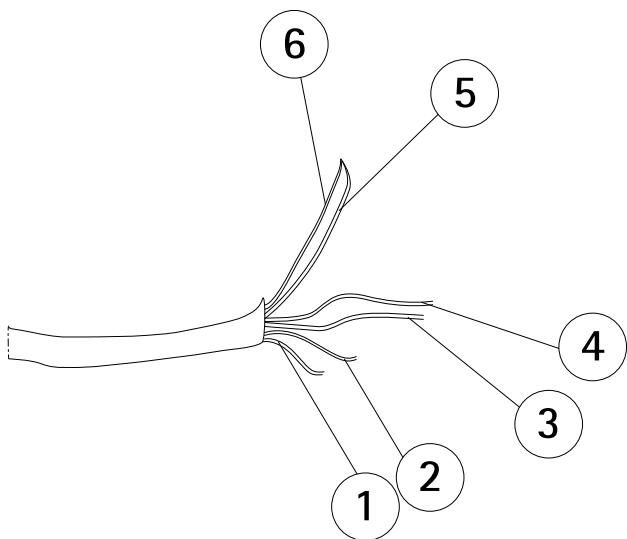

- 1 *Power cable (red)*
- 2 *Power cable (black)*
- 3 *Photocell cable (white)*
- 4 *Photocell cable (yellow)*
- 5 *Telemetry cable (purple)*
- 6 *Telemetry cable (orange)*

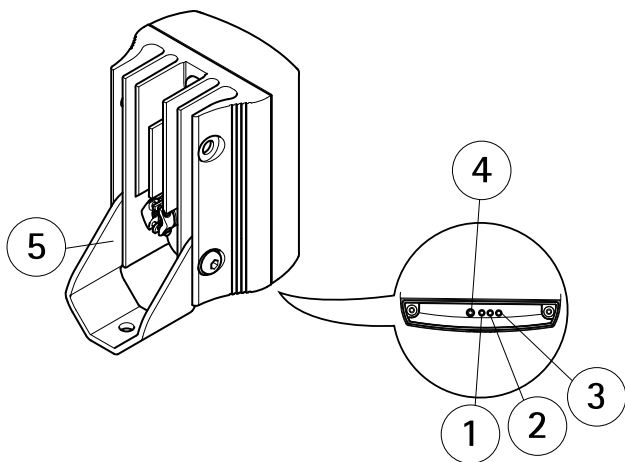

- 1 Red LED indicator
- 2 Amber LED indicator
- 3 Green LED indicator
- 4 Remote control receiver
- 5 Mounting bracket (pre-mounted)

AXIS T90B40 IR-LED

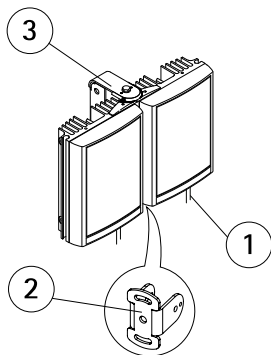

- 1 Cables
- 2 Mounting bracket (pre-mounted)
- 3 Bolt

**Optional Accessories**

**Remote Control**

For information how to use the remote control, see *Access the Product*.

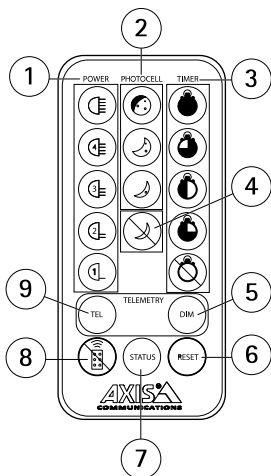

- 1 *POWER ADJUST buttons*
- 2 *PHOTOCELL ADJUST buttons*
- 3 *TIMER buttons*
- 4 *Photocell disable button*
- 5 *DIM button*
- 6 *RESET button*
- 7 *STATUS button*
- 8 *Disable remote control setup button*
- 9 *TELEMETRY button*

## Mounting Brackets

To install the product using a compatible bracket from AXIS T90B Mounting Accessories, see the Installation Guide delivered separately with the mounting bracket.

## LED Indicators

There are three colored LED indicators on the base of the illuminator which provide operating and status information. The color status depends on the current operating mode:

- Programming Mode
- Normal Operating Mode

### *Programming Mode*

LED Indicator	Indicated Behavior
Solid Green	Power on
Flashing Green	Remote control IR receiver error
Solid Amber	Illuminator receiving valid command from remote control
Flashing Amber	Illuminator in Programming Mode
Solid Red	Internal LED error
Flashing Red	Input voltage supply error*

### *Normal Operating Mode*

LED Indicator	Indicated Behavior
Solid Green	Power on
Flashing Green	Remote control IR receiver error

## Normal Operating Mode (Continued)

Solid Amber	Input voltage level error*
Solid Red	Internal LED error

\*Once the voltage error has been corrected, disable the remote control setup or restart the illuminator to turn the status LED off.

## Connectors and Buttons

For specifications and operating conditions, see *page 14*.

### Power Connector

- AC/DC power connector

## Specifications

### Operating Conditions

Product	Temperature	Humidity
AXIS T90B Series	-50 °C to 50 °C (-58 °F to 122 °F)	10–100% RH (condensing)

### Power Consumption

Product	Value
AXIS T90B15 W-LED	12–24 V AC/DC, max 12 W
AXIS T90B20 IR-LED	12–24 V AC/DC, max 24 W

AXIS T90B25 W-LED	12–24 V AC/DC, max 24 W
AXIS T90B30 IR-LED	12–24 V AC/DC, max 48 W
AXIS T90B35 W-LED	12–24 V AC/DC, max 48 W
AXIS T90B40 IR-LED	12–24 V AC/DC, max 96 W

For more information about power consumption, see *Technical Specifications on page 29*

## Install the Hardware

To install the product using a compatible bracket from AXIS T90B Mounting Accessories, see the Installation Guide delivered separately with the mounting bracket.

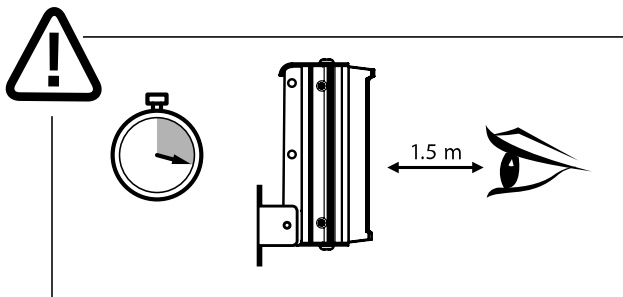

### **⚠CAUTION**

IR emitted from this product. Avoid prolonged eye exposure or use appropriate shielding or eye protection at distances of less than 1.5 m.

Follow these installation procedures:

1. If required, remove the screws and move the standard bracket to the top of the illuminator.
2. If required, loosen the screws and turn the bracket 90°.



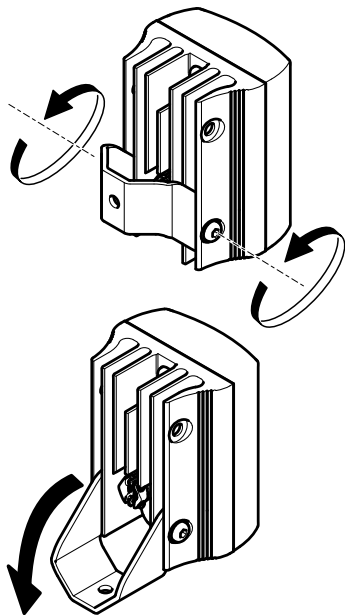

3. If required, loosen the screws and change to a diverging lens with the desired angle of illumination. The angle of illumination should be adjusted according to the camera field of view to light the whole scene adequately. See *Technical Specifications*.

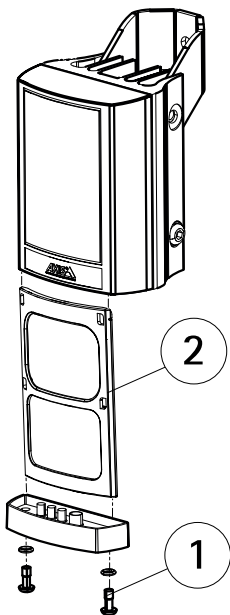

- 1 Screws
- 2 Diverging lens

### Note

Adjust the vertical position of the illuminator to ensure that the field of view of the camera is illuminated.

- Position the illuminator adjacent to the camera and point the illuminator towards the scene.

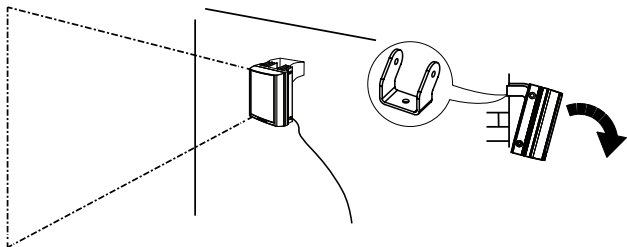

**⚠ CAUTION**

Red cable = +ve, Black cable = -ve (polarity sensitive)

- Mount the power supply.
- Connect the illuminator to the power supply.

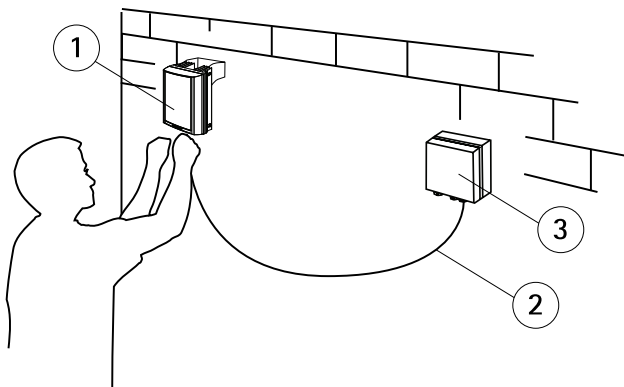

- 1 *Illuminator*
- 2 *Power cable*
- 3 *Power supply*

7. Set photocell following output (White & Yellow) Volt free output – normally open (day) to normally closed (night). Connect direct to camera if required to control switchover of day/night cameras.

## Access the Product

### Programming Mode

The illuminator has the following default settings:

- Power set to maximum 100%
- Photocell set to medium sensitivity level: 10 lux On, 30 lux Off.
- Timer disabled

- Telemetry TEL enabled
- Telemetry input wires soldered together for automatic photocell operation
- Telemetry DIM disabled
- LED status indicators enabled
- Programming Mode

**Note**

Changing the settings requires a remote control (optional accessory). The illuminator must be in Programming Mode.

The illuminator automatically switches from Programming Mode to Normal Operating Mode after 4 weeks. To switch to Programming Mode, restart the illuminator.

1. Adjust the power, see *Power Adjust on page 22*.
2. Adjust the photocell sensitivity, see *Photocell Sensitivity on page 22*.
3. Set the telemetry input:
  - TEL, see *page 24*
  - DIM, see *page 25*
  - Timer, see *page 25*
4. Disable the LED status indicators, see *LED Status Indicators on page 26*.
5. Disable remote control setup, see *Disable Remote Control Setup on page 27*.
6. Restore the factory default settings, see *Factory Default on page 27*.

## Normal Operating Mode

The only function of the Remote Control available during Normal Operating Mode is LED Status Indicators, see *LED Status Indicators on page 26*.

## Power Adjust

The power output of the illuminator can be adjusted between five pre-set levels. Select the required light intensity by using the buttons below.

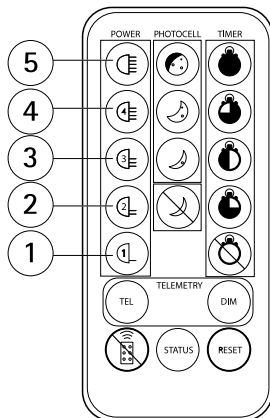

- 1 20% of maximum
- 2 40% of maximum
- 3 60% of maximum
- 4 80% of maximum
- 5 100% of maximum

## Photocell Sensitivity

### Note

When the photocell is disabled the illuminator will turn on and off from a telemetry input, regardless of ambient lighting conditions.

There are three pre-defined levels to set the lux level threshold at which the photocell turns the illuminator on or off. Select the required sensitivity level by using the buttons below.

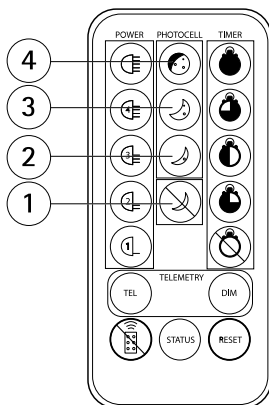

- 1 *Photocell disabled*
- 2 *5 Lux On, 15 Lux Off*
- 3 *10 Lux On, 30 Lux Off*
- 4 *25 Lux On, 50 Lux Off*

## Telemetry Input

The telemetry input wires (orange and purple) are designed to be used with a remote switch or input from an alarm system, PIR detector, control room, video management system or camera output. The input signal can be volt-free or TTL.

Volt-free input:	Non polarity sensitive Short circuit = Light on
TTL input:	Orange = TTL +ve Purple = TTL -ve (GND) 0 V = Light on 3 V = Light off

The telemetry input wires (orange and purple) are soldered together when shipped from the factory to simulate a volt-free input so that the illuminator automatically turns on and off via the photocell. Any remote input or switch should be connected to these wires. Snip the end of the cable and separate the cables to use with remote switch or input.

Under normal operating conditions, a telemetry input will activate the unit only at night provided that the photocell detects low light conditions. However, if the photocell is disabled, a telemetry input will activate the unit regardless of ambient light conditions.

The mode of operation is selected by using the remote control.

The remote input can be used in conjunction with the illuminator in the following ways:

1. TEL – see *page 24*
2. DIM – see *page 25*
3. TEL + TIMER – see *page 25*

### Telemetry - TEL

Press the TEL button if the illuminator is to be turned on and off using a remote switch or input.

The TEL input can be used in various ways:



1. Turn the light on (night) and off (day) automatically via the photocell. This is the standard factory setting, no further action is required.
2. Turn the light on and off from a remote switch or input.
3. Used in conjunction with the Timer Function to turn the light on for a pre-defined period of time.

## Telemetry - DIM

The remote dimming feature allows the brightness of the illuminator to be controlled remotely using the telemetry input wires. Use the DIM button to select this function.

When the DIM function is selected, a telemetry input into the illuminator will vary the brightness up and down. When the telemetry input is first applied, it will start to dim the light and will continue to do so while the telemetry input is active. When telemetry input stops, the light level will stay where it was set. When the telemetry input is activated for a second time, the light will start to brighten. This will continue while the telemetry input is active. This activation and de-activation of the telemetry input will reverse the way the light is dimmed (dim down and dim up), to allow the user to set exactly the level required. Disable the DIM function by pressing the TEL button.

After setting a specific light level using the DIM function, if DIM is disabled and TEL enabled, the last power level set when using the DIM function will be remembered and used by the system unless a new power adjust button is selected.

## Timer

The timer function allows the illuminator to be triggered via a telemetry input and remain on for a pre-defined period of time. There are four pre-defined times and a timer disable function. To select timer function, first press and release the TEL button, then select the duration of the timer as shown below.

If you wish to cancel the timer period and have the illuminator operate under standard telemetry conditions, press Timer Disabled.

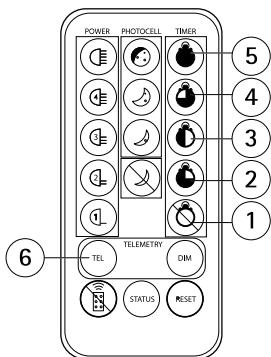

- 1 *Timer disabled*
- 2 *1 minute*
- 3 *3 minutes*
- 4 *10 minutes*
- 5 *30 minutes*
- 6 *TEL button*

### LED Status Indicators

This status indicator function can be switched on and off by pressing the STATUS button. This is the only button that has two states. It is possible for this function to be enabled even if Programming Mode has been disabled so the status of the illuminator can be checked at any time.

## Factory Default

### Note

To activate this feature the button must be pressed continuously for 4 seconds. This is to avoid the possibility of activating this feature accidentally.

Once the illuminator has been programmed, the settings will be stored in a non-volatile (stored) memory. These settings are saved and reloaded if the illuminator experiences loss of power. Press the RESET button to restore the illuminator back to the factory default settings.

## Disable Remote Control Setup

### Note

To enable Programming Mode after remote setup has been disabled, the illuminator must be powered off for at least 10 seconds. When turned on, the illuminator automatically re-enters Programming Mode.

Disable remote setup once an individual illuminator has been programmed and is delivering the required operating performance. This will help to avoid tampering and the possibility of receiving commands when programming other illuminators in close proximity.

Lock the illuminator settings by pressing the Disable Remote Setup button continuously for at least 4 seconds.

If remote control setup is not disabled, the illuminator will remain in Programming Mode for a pre-determined time of 4 weeks. After 4 weeks, remote control setup will be automatically disabled.

## Troubleshooting

Ensure all tests are undertaken by a qualified, trained engineer.

Ensure safe working practices are followed at all times.

- **Basics**
  - Check the LED status indicator. See *LED Indicators*.
  - Check polarity of lamp connection: red = +ve, black = -ve
  - Ensure power is 12-24 V AC or DC
  - Ensure telemetry wires are shorted out or closed contact input (zero volt) is applied
  - Check photocell is working. Cover photocell fully, light should turn on. It is sometimes difficult to see Infra-Red lamps working in high brightness conditions.
  - Make sure that the power cable is within the specified distance.

- **Lamp Test**

**Note**

Use the appropriate multimeter depending on how the illuminator is being powered (AC or DC). Cover the photocell fully (or disable the photocell using the optional remote control) and make sure the telemetry wires are shorted out or closed contact input (zero volt) is applied.

- Check that the current is being drawn. The amount of current will depend on the power setting of the illuminator.
- **Set up Camera, Lens and Illumination**
  - Make sure the power is set to maximum.
  - Check the orientation of illuminator and make sure it is pointing in the correct direction
  - Check angle of the diverging lens. A too narrow angle may cause hot spots and the aperture of the camera lens to close down. A too wide angle may cause insufficient light on the scene.

- Remote Control (optional accessory)
  - Press the STATUS button to check the status of the remote control, see *LED Status Indicators*.
  - Programming may be disabled. Turn the illuminator power off for at least 10 seconds and then turn the power on to enter Programming Mode.
  - In bright sunlight conditions, the distance between the remote control and the illuminator may need to be reduced.
  - Check the battery on the remote control (CR2025), replace if necessary.
  - Make sure no other strong Infra-Red source is pointing at the remote receiver.
  - Make sure there is a clear line of site between the illuminator and the remote control.
  - Check the remote control battery.

## Technical Specifications

Models	AXIS T90B15 W-LED AXIS T90B25 W-LED AXIS T90B35 W-LED AXIS T90B20 IR-LED AXIS T90B30 IR-LED AXIS T90B40 IR-LED
Supported cameras	IR-LED: All Axis cameras with IR cut filter W-LED: All Axis network cameras

<b>Power</b>	Input Voltage: 12-24 V AC/DC AC Frequency: 50-60 Hz Cable length 2.5 m (8 ft)  Power Consumption maximum light / 20% of maximum light / Standby mode: AXIS T90B15 W-LED: 12 W / 3 W / 0.15 W AXIS T90B25 W-LED: 24 W / 6 W / 0.15 W AXIS T90B35 W-LED: 48 W / 12 W / 0.15 W AXIS T90B20 IR-LED: 24 W / 6 W / 0.15 W AXIS T90B30 IR-LED: 48 W / 12 W / 0.15 W AXIS T90B40 IR-LED: 96 W / 24 W / 0.15 W
<b>Control technology</b>	Power level, Photocell sensitivity, Telemetry link for remote activation (if required), Timer
<b>Type</b>	IR-LED: 850 nm semi-covert W-LED luminous power: AXIS T90B15 W-LED: 733 lm AXIS T90B25 W-LED: 1452 lm AXIS T90B35 W-LED: 2840 lm
<b>Color temperature</b>	5700 K (valid for W-LED versions only)
<b>Angle</b>	10° without diverging lens With diverging lenses: 35° 60° 80° 120°* *Optional accessory

Distance	<p><b>AXIS T90B20 IR-LED</b>                      10°x10° - 120 m (394 ft)*                      35°x10° - 65 m (213 ft)                      60°x25° - 45 m (148 ft)                      80°x30° - 30 m (98 ft)                      120°x50° - 20 m (66 ft)**</p> <p><b>AXIS T90B30 IR-LED</b>                      10°x10° - 220 m (722 ft)*                      35°x10° - 120 m (394 ft)                      60°x25° - 65 m (213 ft)                      80°x30° - 45 m (148 ft)                      120°x50° - 30 m (98 ft)**</p> <p><b>AXIS T90B40 IR-LED</b>                      10°x10° - 310 m (1010 ft)*                      35°x10° - 170 m (551 ft)                      60°x25° - 112 m (367 ft)                      80°x30° - 70 m (230 ft)                      120°x50° - 65 m (213 ft)**</p> <p><b>AXIS T90B15 W-LED</b>                      10°x10° - 50 m (164 ft)*                      35°x10° - 35 m (115 ft)                      60°x25° - 20 m (66 ft)                      80°x30° - 15 m (49 ft)                      120°x50° - 10 m (33 ft)**</p> <p><b>AXIS T90B25 W-LED</b>                      10°x10° - 90 m (295 ft)*                      35°x10° - 55 m (180 ft)                      60°x25° - 30 m (98 ft)                      80°x30° - 20 m (66 ft)                      120°x50° - 15 m (49 ft)**</p> <p><b>AXIS T90B35 W-LED</b>                      10°x10° - 150 m (492 ft)*                      35°x10° - 80 m (262 ft)                      60°x25° - 45 m (148 ft)</p>
----------	--

## AXIS T90B Series

---

	80°x30° - 30 m (98 ft) 120°x50° - 20 m (66 ft)**  *No diverging lens **Optional accessory
Casing	Material: Polycarbonate IR-LED: Black W-LED: White and silver
Display and indicators	LED indicators
Environment	Outdoor
Mounting	Wall Ceiling Column Camera housing
Approvals	EN 55022 Class B, EN 55024 EN 61547, EN 55015, EN 50130-4 C-tick AS/NZS CISPR 22 Class B FCC Part 15 Subpart B Class B ICES-003 Class B KCC KN22 Class B, KN24 IEC/EN 60598-1 IEC/EN 62471 Risk group 2* IEC/EN 60529 IP66 REACH, WEEE, CE  *Valid only for IR-LED products
Operating conditions	-50 °C to 50 °C (-58 °F to 122 °F) 10-100% RH (condensing)



<b>Dimensions (HxWxL)</b>	The size of the product shall be maximum (WxHxL): AXIS T90B15 W-LED: 75 x 100 x 64 mm (3 x 4 x 2.5 in) AXIS T90B25 W-LED: 100 x 135 x 66 mm (4 x 5 x 2.5 in) AXIS T90B35 W-LED: 135 x 180 x 68,2 mm (5 x 7 x 3.2 in) AXIS T90B20 IR-LED: 100 x 135 x 66 mm (4 x 5 x 2.5 in) AXIS T90B30 IR-LED: 135 x 180 x 68,2 mm (5 x 7 x 3.2 in) AXIS T90B40 IR-LED: 279 x 223 x 68 mm (11 x 9 x 3 in)
<b>Weight</b>	AXIS T90B15 W-LED: 600 g (1.3 lbs) AXIS T90B25 W-LED: 950 g (2.1 lbs) AXIS T90B35 W-LED: 1650 g (3.6 lbs) AXIS T90B20 IR-LED: 950 g (2.1 lbs) AXIS T90B30 IR-LED: 1650 g (3.6 lbs) AXIS T90B40 IR-LED: 4500 g (9.9 lbs)
<b>Included accessories</b>	3 diverging lenses: 35° (pre-mounted) 60° 80°
<b>Optional accessories</b>	Power supply Mounting brackets AXIS T90B Remote Control Diverging lens (120° angle)

## Further Information

Visit Axis learning center [www.axis.com/academy](http://www.axis.com/academy) for useful trainings, webinars, tutorials and guides.

### Warranty Information

For information about Axis' product warranty and thereto related information, see [www.axis.com/warranty/](http://www.axis.com/warranty/)



Installation Guide

AXIS T90B Series

© Axis Communications AB, 2014

Ver. M3.2

Date: August 2014

Part No. 59159