



# **GST200N Series Intelligent Fire Alarm Control Panel**



**Installation and Operation Manual**

*Issue 1.08 November 2013*

ERP:30309169



## CONTENTS

<b>Installation Precautions</b> .....	<b>1</b>
<b>Preface EN 54 Information</b> .....	<b>2</b>
<b>Chapter 1 Product Introduction</b> .....	<b>3</b>
<b>Chapter 2 Technical Specifications</b> .....	<b>4</b>
2.1 AC Mains Power .....	4
2.2 Standby Power .....	4
2.3 PSU Load .....	4
2.4 Communication Loop Parameters .....	4
2.4.1 RS485 Communication Loop .....	4
2.4.2 RS232 Communication Loop .....	5
2.4.3 CAN Communication Loop .....	5
2.5 Detection Loop Parameters .....	5
2.6 Output Loop Parameters .....	6
2.7 Dimensions .....	6
<b>Chapter 3 Construction and Components</b> .....	<b>7</b>
3.1 Appearance and Internal Construction.....	7
3.1.1 Display Area.....	8
3.1.2 Description of LEDs .....	8
3.1.3 Description of Keys .....	9
3.1.4 Zone Indication and Manual Interventional Panel (ZCP).....	10
3.2 Components .....	11
3.2.1 Standard Components .....	11
3.2.2 Optional Units .....	11
3.3 Peripheral Devices.....	14
3.3.1 A Series of Intelligent Fire Detectors.....	14
3.3.2 Modules .....	14
3.3.3 Loop Isolator .....	14
3.3.4 Manual Call Points.....	14
3.3.5 Sounder Strobes.....	15
3.3.6 Repeater Panel.....	15
3.4 Defining Tool Software .....	15
<b>Chapter 4 Installation</b> .....	<b>16</b>
4.1 Component Inspection.....	16
4.2 Installing the Cabinet .....	16
4.3 Start-up Check.....	17
4.4 Connection of Peripheral Devices.....	17
4.4.1 Connection of Mains Power .....	17
4.4.2 Connection of Batteries.....	18
4.4.3 Connection of Peripheral Devices.....	18
4.5 Connection Checking and Device Registration.....	22
4.5.1 Connection Checking.....	22
4.5.2 Device Registration.....	22
4.6 Device Definition.....	23
4.7 Field Device Commission .....	23
<b>Chapter 5 Display and Disposal of System Information</b> .....	<b>24</b>
5.1 Normal Information .....	24

5.2 Fire Alarm .....	24
5.2.1 Fire Alarm Screen .....	24
5.2.2 Disposal of Fire Alarm Signal .....	25
5.3 Fault.....	25
5.3.1 Fault Indication .....	25
5.3.2 Disposal of Fault Message.....	27
5.4 Rules for Message Display .....	27
5.5 Rules for Sound Indication.....	27
<b>Chapter 6 Description of System Operation .....</b>	<b>28</b>
6.1 Keypad .....	28
6.1.1 Keypad Functions .....	28
6.1.2 Methods of Data Input.....	28
6.1.3 Unlocking and Locking the Keypad.....	28
6.2 User Operation Instruction (No Password Requirement).....	28
6.2.1 Changing displayed time.....	28
6.2.2 Browsing messages.....	29
6.2.3 Silencing the panel.....	34
6.3 Instructions for Operator (Operator Password Required) .....	34
6.3.1 Resetting the system .....	35
6.3.2 Alarm Silence.....	35
6.3.3 Evacuation .....	35
6.3.4 Disable/Enable.....	35
6.3.5 User Mode .....	39
6.3.6 Device Start/Stop through ZCP.....	41
6.3.7 Test Mode Setup .....	41
6.4 Instructions for System Administrator (Manager Password Required).....	43
6.4.1 Modifying System Time.....	43
6.4.2 Modifying Password.....	43
6.4.3 Network Setup .....	44
6.4.4 Setting up Beginning Zone Number .....	45
6.4.5 Customize.....	45
6.4.6 System Initialization .....	47
<b>Chapter 7 Standby Battery Calculations .....</b>	<b>48</b>
<b>Chapter 8 Maintenance .....</b>	<b>49</b>
8.1 Replacing the Battery .....	49
8.2 Replacing the Fuses .....	49
8.3 Troubleshooter.....	49
<b>Appendix 1 Internal Connection Diagram .....</b>	<b>51</b>
<b>Appendix 2 Internal Fault Description .....</b>	<b>52</b>
<b>Appendix 3 Device Type List .....</b>	<b>53</b>
<b>Appendix 4 Operation Menu.....</b>	<b>55</b>

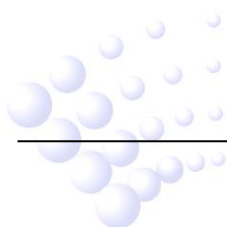

## Installation Precautions

Adherence to the following will aid in problem-free installation with long-term reliability:

- ✧ Do not attempt to install, service, or operate this unit until this manual is read and understood.
- ✧ This unit must be installed in accordance with these instructions and the appropriate national, regional and local regulations specific to the country and location of the installation. Consult with the appropriate Authority Having Jurisdiction (AHJ) for confirmation of the requirements.
- ✧ GST200N Series Intelligent Fire Alarm Control Panel (FACP) shall only be installed and serviced by trained specialist.
- ✧ Disconnect all sources of power before servicing. Control unit and associated equipment may be damaged by removing and/or inserting cards, modules, or interconnecting cables while the unit is energized.
- ✧ Remove all electronic assemblies prior to any drilling, filing, reaming, or punching of the enclosure. When possible, make all cable entries from the sides or rear. Before making modifications, verify that they will not interfere with battery, transformer, and printed circuit board location.

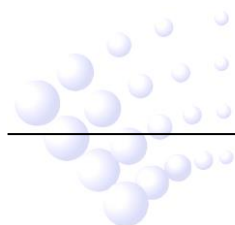

## Preface EN 54 Information

- EN 54** ✓ ✧ GST200N Series Intelligent Fire Alarm Control Panel (FACP) complies with the requirements of EN 54-2 1997+A1: 2006 and EN 54-4 1997+A1: 2002+A2: 2006. In addition to the basic requirements of these standards, the panel conforms to the following optional requirements.

Option		EN 54-2 Clause
Indication	Fault signals from points	8.3
Control	Delays to Outputs	7.11
	Disablement of addressable points	9.5
Outputs	Output to fire alarm devices	7.8
	Outputs to fire protection equipment	7.10

- EN 54** ✓ ✧ The power supply of GST200N Series FACP complies with EN 54-4 requirements.

AC-DC 150W Power Supply	EN 54-4 Clause
Power supply from the main power source	5.1
Power supply from the standby power source (battery)	5.2
Charger	5.3
Faults	5.4

- EN 54** N/A ✧ In addition to functions required by EN 54-2, the panel supports a number of ancillary functions that are not required. These are outlined below:

Ancillary Function	Manual Section
Printer Module Kit	3.2.2
RS232 output	2.3 & 3.2.2
GST852RP Repeater Panel	3.3.6
Defining Tool	3.4
Fire alarm output	4.4.3.3
RS485 & CAN output	2.3 & 4.4.3.5
Connection of SOUNDER CIRCUIT OUTPUT	4.4.3.1
PAS	6.3.5.4&6.4.5.2

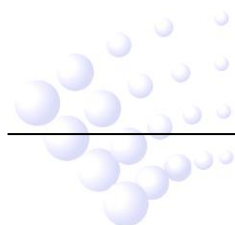

## Chapter 1 Product Introduction

GST200N Series Intelligent Fire Alarm Control Panel (FACP) is designed to comply with EN 54-2 standard with qualities of simple installation, operation, and maintenance. It is used in fire alarm system with the following features:

- ✧ It controls at most 30 zones. Each zone has its own alarm and fault/disable LEDs and a label.
- ✧ Maximum two Class A loops. The first loop can have up to 235 addressable devices, and the second up to 242 devices. It is compatible with a series of addressable GST products, which are intelligent sounder strobe complying with EN 54-3, heat detector complying with EN 54-5, photoelectric smoke detector complying with EN 54-7, intelligent manual call point complying with EN 54-11, intelligent reflective beam detector complying with EN 54-12, input and output module complying with EN 54-18, and loop isolator complying with EN 54-17.
- ✧ The LCD can display 8 lines in total and 18 characters each line, assisting the 15 LEDs in displaying important information.
- ✧ The memory does not lose data even if power supply is accidentally removed.
- ✧ It has manual keys for each zone, which can activate/silence the sounder strobes separately.
- ✧ Automatically prompting operation steps for every alarm device and for smoke exhaust and fire extinguishing equipment by field programming.
- ✧ Sounder strobe interface provides 0.5A/24V output, compatible with GST convention sounder strobes complying with EN 54-3.
- ✧ Optional RS232 interface enables communication with PC.
- ✧ Optional RS485 Network Card or CAN Network Card for fire alarm network.
- ✧ Optional RS485 Network Card Loop Type or CAN Network Card Loop Type for Loop type fire alarm network.
- ✧ Optional Printer Module Kit, it can print operation and fire alarm messages.
- ✧ Optional USB Printer Interface Card, it can externally connect with a printer through USB to print operation and fire alarm messages.

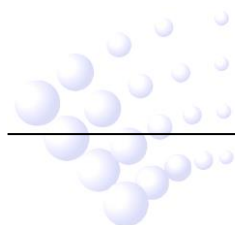

## Chapter 2 Technical Specifications

### 2.1 AC Mains Power

- ✧ Input Voltage: 100-240VAC
- ✧ Frequency: 50-60Hz
- ✧ Input Current: 1.5A
- ✧ Fuse: 2A delay
- ✧ Recommended Wiring: 1.5mm<sup>2</sup> or above screened cable, complying with local installation code.

### 2.2 Standby Power

- ✧ Battery Voltage: 24VDC
- ✧ Battery Maximum Operating Current: 2.82A
- ✧ Quiescent Current under Full-loaded Condition: 0.75A
- ✧ Maximum Internal Resistance: 1Ω
- ✧ Maximum Charge Voltage: 27.6V
- ✧ Maximum Charge Current: 1.2A
- ✧ Maximum Charge Capacity: Two 12V/21Ah batteries
- ✧ Type: Sealed lead acid batteries
- ✧ Recommended manufacturer and model of battery: Power-Sonic PG12V21
- ✧ Internal Space for Batteries (L x W x H): 181mm×77mm×167mm. This space can be expanded to 390mm×155mm×167mm by removing the battery holder.

### 2.3 PSU Load

- ✧ The maximum 24VDC output current is 0.37A and the maximum 5VDC output current is 0.78A in standby condition (Max.a as described in EN 54-4 Clause 9.2.1 table 1.)
- ✧ The maximum 24VDC output current is 2.1A and the maximum 5VDC output current is 1.0A in alarm condition (Max.b as described in EN 54-4 Clause 9.2.1 Table 1).

### 2.4 Communication Loop Parameters

#### 2.4.1 RS485 Communication Loop

- ✧ RS485 Network Card or RS485 Network Card Loop Type.
- ✧ NETWORK (A, B): Communication cable for connecting with up to 32 network FACPs.
- ✧ REPEATER (A, B): Communication cable for connecting with up to 10 repeater panels.
- ✧ Recommended Wiring (subject to local installation codes):
  - Vencroft Gold and Platignum
  - Nexans NX 200 and 200 Plus (LPCB tested)



- Prysmian FP 200 and 200 Gold
- Draka Firetuf and Firetuf Plus
- And all LPCB approved Fire cables
- ✧ Recommended Cable Length  $\leq$  1000m

#### 2.4.2 RS232 Communication Loop

RS232 communication loop is connected with a PC for running Graphic Monitor Center (GMC) system through a DB9 port.

Recommended Wiring: Standard RS-232 interface. The 2<sup>nd</sup> pin (for sending data), the 3<sup>rd</sup> pin (for receiving data), and the 5<sup>th</sup> pin (ground) are connected with PC through three-core shield cable.

**Note: Wire length should be less than 15m; the screening layer and computer's enclosure should be earthed. If you use GST control panel for the first time, please purchase a RS232 card. Device definitions and equations are only downloaded through this card.**

#### 2.4.3 CAN Communication Loop

- ✧ Optional CAN Network Card (For future use) or CAN Network Card Loop Type can be used.
- ✧ CAN\_H, CAN\_L: Communication loop, connecting maximum 240 control panels of other type into the network.
- ✧ Recommended Wiring (subject to local installation codes):
  - Vencroft Gold and Platignum
  - Nexans NX 200 and 200 Plus (LPCB tested)
  - Prysmian FP 200 and 200 Gold
  - Draka Firetuf and Firetuf Plus
  - And all LPCB approved Fire cables
- ✧ Recommended Cable Length  $\leq$  1000m

### 2.5 Detection Loop Parameters

- ✧ **LOOP OUT (+, -):** Polarized signal cable from the 1<sup>st</sup> loop of the FACP connecting up to 235 addressable devices.
- ✧ **LOOP IN (+, -):** Polarized signal cable from the 1<sup>st</sup> loop returning to the FACP.
- ✧ **LOOP2 ZO (+, -):** Polarized signal cable from the 2<sup>nd</sup> loop of the FACP connecting up to 242 addressable devices.
- ✧ **LOOP2 ZI (+, -):** Polarized signal cable from the 2<sup>nd</sup> loop returning to the FACP.
- ✧ Output Voltage: 21V~27V pulse
- ✧ Output Current: 0mA~300mA
- ✧ Type of Loop: Class A loop
- ✧ Recommended Wiring (subject to local installation codes):
  - Vencroft Gold and Platignum
  - Nexans NX 200 and 200 Plus (LPCB tested)
  - Prysmian FP 200 and 200 Gold
  - Draka Firetuf and Firetuf Plus
  - And all LPCB approved Fire cables.

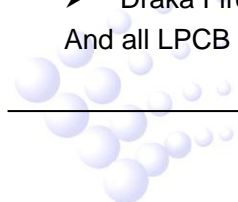



- ✧ Recommended Cable Length  $\leq$  1000m

## 2.6 Output Loop Parameters

- ✧ FIRE ALARM OUTPUT (+, -)
  - Output Voltage: 21VDC~27VDC
  - Output Current: 0mA~500mA
  - End of Line Resistor: 4.7k $\Omega$
- ✧ F.P.E. OUTPUT (+, -)
  - Output Voltage: 21VDC~27VDC
  - Output Current: 0mA~500mA
  - End of Line Resistor: 4.7k $\Omega$
- ✧ SOUNDER CIRCUIT OUTPUT (+, -)
  - Output Voltage: 21VDC~27VDC
  - Output Current: 0mA~500mA
  - End of Line Resistor: 4.7k $\Omega$
- ✧ FAULT OUTPUT (NC, COM, NO)
  - Contact Capacity: 24VDC @1.0A
  - In fault state, NC and COM open, NO and COM close.
- ✧ Recommended Wiring (subject to local installation codes):
  - Vencroft Gold and Platignum
  - Nexans NX 200 and 200 Plus (LPCB tested)
  - Prysmian FP 200 and 200 Gold
  - Draka Firetuf and Firetuf PlusAnd all LPCB approved Fire cables
- ✧ Recommended cable length  $\leq$  1000m

## 2.7 Dimensions

420mm  $\times$  580mm  $\times$  202mm

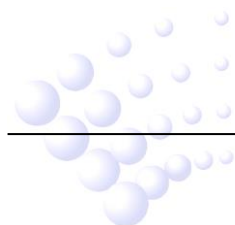

## Chapter 3 Construction and Components

### 3.1 Appearance and Internal Construction

GST200N Series FACP is flush-mounted. Its appearance and internal structure are shown in Fig. 3-1 and 3-2.

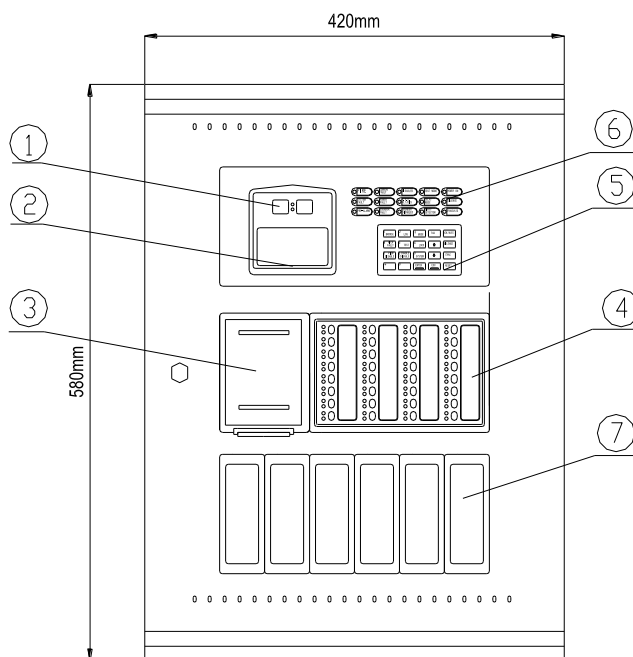

Fig. 3-1

1 Clock 2 LCD 3 Printer panel 4 Zone indication and manual intervention panel (ZCP)  
 5 Keypad 6 LED 7 Optional units (Fireman's Control Panel, FCP)

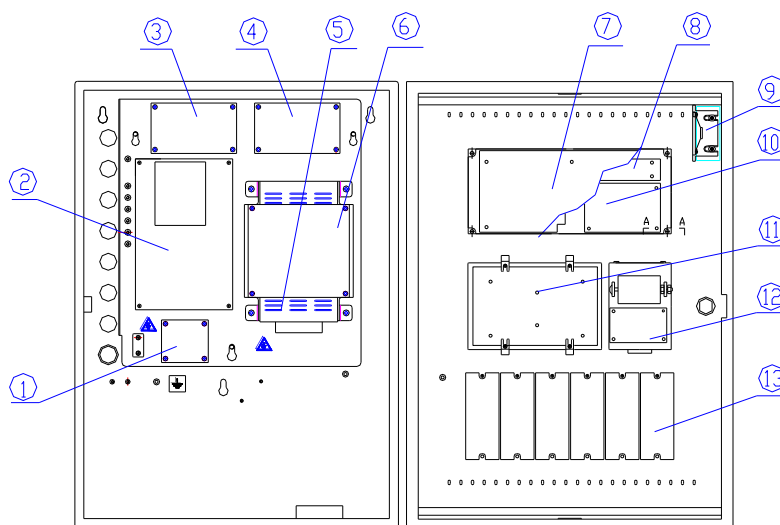

Fig. 3-2

1 Terminal Board 2 Loop interface board 3 Loop Board (optional) 4 Communication Board (optional) 5 AC-DC Power Supply 6 Power Management Board 7 Main Board

8 Switch Board 9 Speaker 10 LCD 11 Zone indication and manual intervention panel (ZCP) 12 Printer (optional) 13 Optional units (FCP-fireman's control panel)

### 3.1.1 Display Area

The display area consists of clock, LCD, LED and keypad, which are shown in Fig. 3-3.

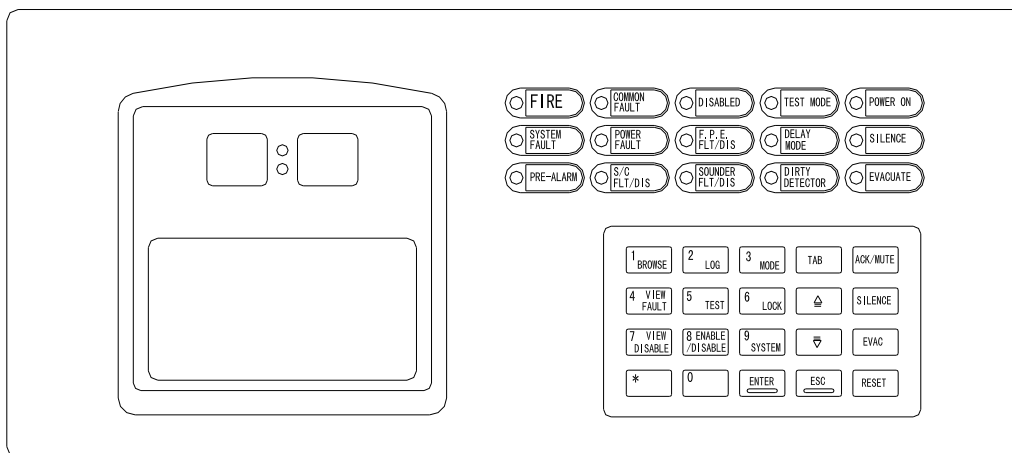

Fig. 3-3



### 3.1.2 Description of LEDs

- ✧ **FIRE:** Red. It illuminates when the FACP detects an alarm condition of connected detectors. After fire condition is removed, the fire status can only be cleared by pressing *RESET* key, and this LED goes out simultaneously.
- ✧ **COMMON FAULT:** Yellow. It illuminates when the FACP detects fault of connected devices or itself. It goes out automatically after the fault condition is removed.
- ✧ **DISABLED:** Yellow. It illuminates when any connected devices, zones or outputs are disabled. It goes out when such status is canceled.
- ✧ **TEST MODE:** Yellow. It illuminates when any zone is in test mode. It goes out when test mode is canceled.
- ✧ **POWER ON:** Green. It illuminates when the mains power or battery is normal.
- ✧ **SYSTEM FAULT:** Yellow. It illuminates if the program encounters a dead halt or the system cannot work normally. After the fault condition is removed, only by pressing *RESET*, can system fault be cleared, and this LED goes out.
- ✧ **POWER FAULT:** Yellow. It illuminates when the mains power, battery or charger of the FACP is in fault condition. It goes out when the fault is cleared.
- ✧ **F.P.E. FLT/DIS:** Yellow. It flashes when F.P.E. output is in fault and illuminates steadily after the F.P.E. output is disabled. It goes out after fault and disabled conditions are cleared.
- ✧ **DELAY MODE:** Yellow, it illuminates when the output is set in delay mode. It goes out when the delay mode is canceled.
- ✧ **SILENCE:** Yellow. It illuminates when the sounders are silenced. It goes out until a new alarm comes, or the FACP is reset or *EVAC* key is pressed.

- ✧ **PRE-ALARM:** Red. It illuminates when there is pre-alarm message.
- ✧ **S/C FLT/DIS:** Yellow. It flashes when SOUNDER CIRCUIT OUTPUT is in fault condition. It illuminates when SOUNDER CIRCUIT OUTPUT is disabled. It goes out automatically after the fault or disabled condition is cleared.
- ✧ **SOUNDER FLT/DIS:** Yellow. It flashes when any loop sounder is in fault. It illuminates when any loop sounder is disabled. It goes out when the fault or disabled condition is cleared.
- ✧ **DIRTY DETECTOR:** Yellow. It illuminates when any smoke detector is dirty. It goes out when the FACP is reset.
- ✧ **EVACUATE:** Red. It illuminates when *EVAC* key is pressed for evacuation. It goes out until the FACP is reset or silenced.

### 3.1.3 Description of Keys

- ✧ **ACK/MUTE:** Pressing this key will manually acknowledge an alarm and silence the FACP. If new alarm comes, the FACP will sound again. In PAS (Positive Alarm Sequence) mode, pressing this key in 15 seconds after the alarm will start the second-stage delay.
- ✧ **SILENCE:** For silencing all sounders in the system, and lighting the *SILENCE* LED. This key requires operator password.
- ✧ **EVAC:** For starting all sounders in the system, and lighting the *EVACUATE* LED. This key requires operator password.
- ✧ **RESET:** For clearing all alarm messages, all detector alarms, and all outputs in order to reset the FACP to normal state. This key requires operator password.
- ✧ **BROWSE:** Pressing this key will enter device-browsing screen to browse devices by loop, by zone or by group, to check zones in test, to browse definition of communication devices, to browse definition of ZCP or to browse cause and effect equations.
- ✧ **LOG:** For searching and browsing history records.
- ✧ **MODE:** Pressing this key (operator password required) can enter setup screen to set contrast, message display mode, printing mode, pre-alarm mode, and manual start or stop mode.
- ✧ **VIEW FAULT:** Pressing this key can check all fault messages if the LCD is not displaying fault messages.
- ✧ **TEST:** Pressing this key can enter test setup screen to self-test the FACP, to set a zone into test mode, to set a zone to exit test mode, and to set all zones to exit test mode. This key requires operator password.
- ✧ **LOCK:** Locking the keypad when it is unlocked.
- ✧ **VIEW DISABLE:** Pressing this key can check all disabled messages if the LCD is not displaying disabled messages.
- ✧ **ENABLE/DISABLE:** Pressing this key can enter ENABLE/DISABLE screen to enable/disable devices, outputs or delayed outputs, and to delete disablement through network. This key requires operator password.

- ✧ **SYSTEM:** System set-up key, used for setting system time, modifying operator password and manager password, setting network system, setting beginning zone number, setting output mode, system initialization and viewing supervisory data of addressable devices. This key requires manager password.
- ✧ **ENTER:** Confirming inputs to be valid. In normal standby state, pressing it can make the clock display change between month/day mode and hour/minute mode.
- ✧ **ESC:** For canceling or exiting the operating menu. If it's pressed when the FACP is displaying messages, it will resume to display messages of the highest level.
- ✧ **TAB:** For shifting to display different messages or moving the cursor when entering text.
- ✧ ,  : For moving the cursor up or down.
- ✧ **\***: For entering the wild card "\*" representing numbers 0 ~ 9.
- ✧ **0~9:** For entering numbers.

### 3.1.4 Zone Indication and Manual Interventional Panel (ZCP)

Appearance of the ZCP is shown in Fig. 3-4.

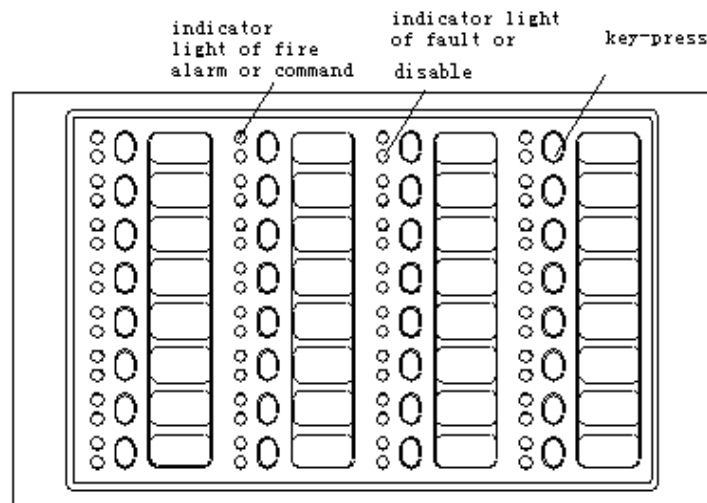
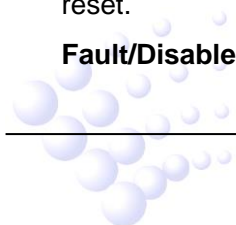

Fig. 3-4

On the ZCP, each unit consists of a start/stop key, two indicators and a label. The key is for start/stop control. Device labels can be stuck on the right side of the keys, and the user can put the corresponding names on them. Zone indication and manual intervention panel can complete the following functions through defining.

#### 3.1.4.1 Zone Indication

- ✧ **LEDs**
  - Fire:** Red. It illuminates when a fire occurs in a zone. It goes out after the FACP is reset.
  - Fault/Disable:** Yellow. It flashes when there is any fault with the zone. If all devices



in this zone have been disabled, the LED illuminates steadily. It goes out after the fault conditions are cleared or the FACP is reset.

- ✧ The key of a zone is used to activate/silence sounder strobes in the zone.

### 3.1.4.2 Device Operation

- ✧ **Command LED:** Red. It illuminates when start command is given and goes out when stop command is given or the FACP resets.
- ✧ **Keys:** Pressing it can start a device. If a device is started, pressing this key will stop it.

## 3.2 Components

### 3.2.1 Standard Components

GST200N series control panel comprises of single loop type and two loop type. Single loop type control panel can become a two loop type through adding to a loop board.

A standard single loop type FACP consists of main board, loop interface board, power supply, display area, and zone indication and manual intervention panel (ZCP).

- ✧ **Main board**

Main board is the core of the FACP, which contains CPU and interfaces to other main parts and optional parts.

- ✧ **Loop interface board**

This is the signal interface of the FACP, containing ports for communication, detection, fire alarm output and fault output etc. The loop interface board connects field devices and the FACP into a complete fire alarm system.

- ✧ **Power supply**

It provides power of 110V-240V to the main board, loop interface board and printer. Its backup feature ensures that devices registered during commission will not be lost in case of power fault. It has features such as low-voltage protection, switching between the main power and the battery power, charger, and monitoring faults of the main power, battery power and charger.

- ✧ **Display area**

This part is used to indicate and display different status of the system, and enables relative operations through keypad (browsing, programming, printing and etc).

- ✧ **Zone indication and manual intervention panel (ZCP)**

The ZCP can indicate fire alarm, fault/disable state of corresponding devices, and start and stop them accordingly.

### 3.2.2 Optional Units

- ✧ **Loop board**

The loop board is used as the second Class A detection interface for connecting more addressable devices. The construction of the loop board is shown in Fig. 3-5.

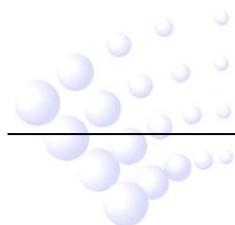

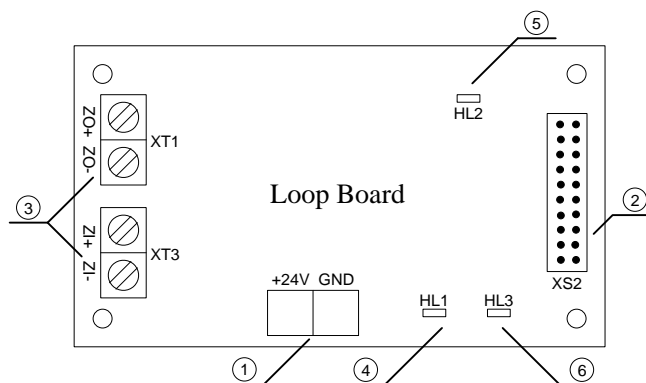

Fig. 3-5

- 1 24VDC power input.
- 2 20P data cable port (XS2), connecting to the main board.
- 3 Class A output, wiring method is the same as that of Class A detection loop on loop interface board. Refer to Section 4.4.3.4 for details.
- 4 Loop-shift indicator HL1, red. It illuminates when the loop line shifts.
- 5 Loop output shut-down indicator HL2, red. It illuminates when the loop output is shut down.
- 6 Communication indicator HL3, red. It illuminates when communicating with the main board.

✧ **Communication card**

GST200N Series Intelligent Fire Alarm Control Panel (FACP) provides a multi-functional communication port, connecting with network cards with different functions to realize networking among GST series FACPs. The FACP monitors the running of network cards in real time so that the card can work after being inserted.

GST200N Series provides four types of network cards:

- **RS485 Network Card**
- **RS485 Network Card Loop Type**
- **CAN Network Card**
- **CAN Network Card Loop Type.**

Their structures are shown in Fig. 3-6 and 3-7.

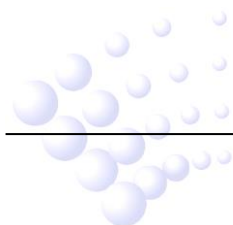



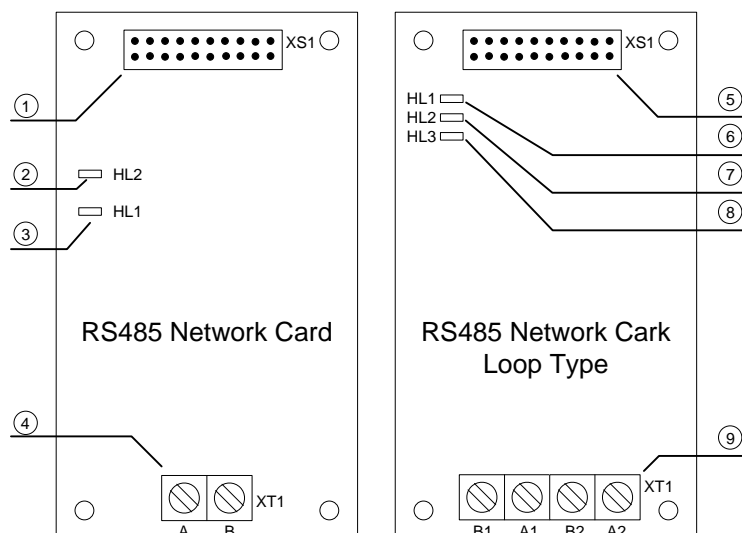

Fig. 3-6

Description:

- 1 20P data cable port XS1, connecting to the main board.
- 2 Green indicator HL2. It flashes when communicating with network.
- 3 Red indicator HL1. It flashes when communicating with main board.
- 4 RS 485 network communication terminal XT1 (A, B).
- 5 20P data cable port XS1, connecting to the main board.
- 6 Red indicator HL1. It flashes when communicating with main board.
- 7 Green indicator HL2. It flashes when communicating with loop 1<sup>st</sup> of RS485.
- 8 Green indicator HL3. It flashes when communicating with loop 2<sup>nd</sup> of RS485.
- 9 RS485 network communication terminals XT1 (A1, B1, A2, B2).

**Note: You need to include an RS232 card in your first order of GST200N FACP. Only with this card, device definition and C&E equations can be downloaded from PC.**

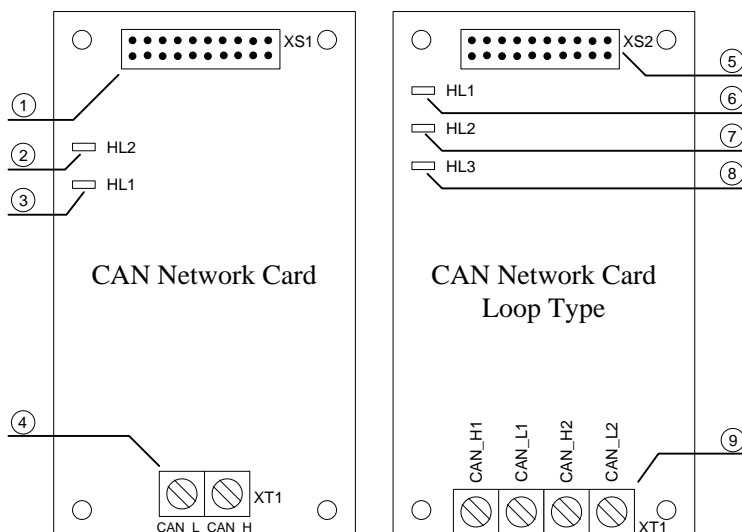

Fig. 3-7

Description:

- 1 20P data cable port XS1, connecting to the main board.

- 2 Green indicator HL2. It flashes when communicating with network.
- 3 Red indicator HL1. It flashes when communicating with main board.
- 4 CAN network communication terminal XT1 (CAN\_H, CAN\_L).
- 5 20P data cable port XS2, connecting to the main board.
- 6 Red indicator HL1. It flashes when communicating with main board.
- 7 Green indicator HL2. It flashes when communicating through CAN1.
- 8 Green indicator HL3. It flashes when communicating through CAN2.
- 9 CAN loop communication terminal (CAN\_H1, CAN\_L1, CAN\_H2, CAN\_L2).

✧ **Printer Module Kit**

It is a built-in micro printer. With dot matrix printing it can print 96 kinds of ASCII code characters (capital or lower case of Latin letters, figures and symbols), 128 coded non-standard characters and chart symbol (some Chinese characters, Greek letters, block symbol etc.), and 16 code characters (6×7 dot) which can be defined by the user through programming, and replace any code font by command, so as to print characters of different language.

✧ **USB Printer Interface Card**

It can be connected with needle printer through USB cable. The connects printed are the same as that of USB Printer Module Kit. The test are more eligible, in convenient for reading and saving.

### 3.3 Peripheral Devices

#### 3.3.1 A Series of Intelligent Fire Detectors

GST200N Series can connect with a series of fire detectors, such as I-9102, I-9103, and I-9105R. The detectors mounted in the protected area transmit monitoring message to the FACP through Class A loop. Every detector has its own address with which the FACP can supervise the information of alarm, fault, and normal status of the detectors.

#### 3.3.2 Modules

GST200N Series can connect with Addressable Input Module and Addressable Single I/O Module. Input module is used for receiving normally open digital signal from fire protection devices and transmitting the signal back to the fire alarm control panel.

Output module is for connecting fire protection devices that need to be controlled by the FACP, such as smoke valve, fresh air valve, and damper valve. It can also receive answer signal from these devices.

#### 3.3.3 Loop Isolator

Loop Isolator can remove the shorted part of loop from the whole system to ensure normal operation of other devices and to ascertain the location of the part in fault. After the fault is repaired, the loop isolator can automatically reset the removed part into the system.

#### 3.3.4 Manual Call Points

A series of manual call points can be connected to the loop of GST200N Series. When

fire is confirmed manually, pressing the glass on the MCP, alarm signal can be sent to the FACP. After receiving the alarm signal, the FACP will show the number and location of the MCP, and sound alarm.

### **3.3.5 Sounder Strobes**

Addressable sounder strobe is a kind of audible/ visual alarm device installed in the protected area, which can be activated by the FACP at the fire control center or by manual call points. A series of GST addressable sounder strobes can be connected to the loop of GST200N Series. After activated, it will generate strong audible/ visual alarm signal.

### **3.3.6 Repeater Panel**

Repeater Panel is designed with a microprocessor. When one or more detectors alarm fire, the repeater panel can display the location and alarm message of the detectors with audible and optical signals. Through communication loops, it can be connected with FACPs, disposing and displaying the data from the FACPs. When monitoring several floors or several zones with one fire alarm control panel, a repeater panel on each floor or in each zone can replace zonal fire alarm control panel.

## **3.4 Defining Tool Software**

This software is used for editing and downloading definition of device and C&E equation. Before the system starts operation, you need to define the device and C&E using this software on a computer, and then download them to the FACP.

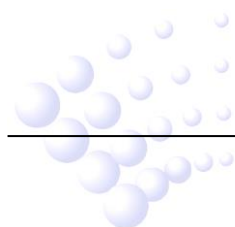

## Chapter 4 Installation

The steps below are guidance for installation of the FACP.

- 1 Check if you have received all items ordered.
- 2 Install the cabinet.
- 3 Power up the FACP and carry out start-up test.
- 4 Connect field devices.
- 5 Check circuits and register devices.
- 6 Define devices and C&E equations on a PC and download them to the FACP through definition software according to installation configuration.
- 7 Check and commission field devices.

### 4.1 Component Inspection

Before installation, check the following items:

#### ✧ Check Installation Requirement

Check the components according to packing list. The main items to be examined are: installation and operation manual, keys to the FACP, etc.

#### ✧ Check Internal Components and Interconnection of the FACP

All internal parts have been connected (including optional units ordered) before the FACP leaves the factory. Therefore, you can mainly check the zone indication and manual intervention panel and power supply, and the connection among parts, including the connection between main board and power supply, switch board and loop interface board, the connection of the zone indication and manual intervention panel with switch board, and of speaker and main board etc. Please refer to Appendix 1 for the internal connection diagram.

### 4.2 Installing the Cabinet

Dimension of the cabinet is shown in Fig. 4-1.

The FACP is intended for indoor use where the altitude is under 2000 meters, transient overvoltage is within Overvoltage Category II and Pollution Degree is 2 (EN 61010-1:2010).

Installation Environment: 0°C~+40°C, relative humidity ≤ 95%, non-condensing

Storage Environment: -5°C~+50°C, relative humidity ≤ 95%, non-condensing

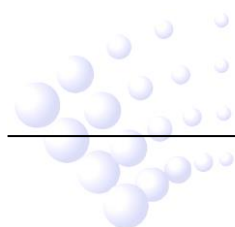

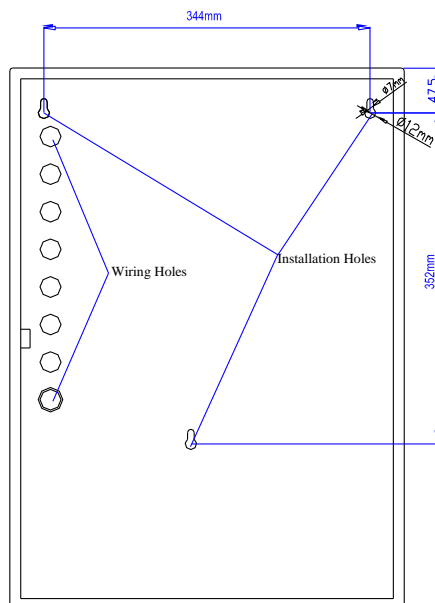

Fig. 4-1

### 4.3 Start-up Check

After installation, apply power to it as shown in Fig. 4-2. Turn on the mains and plug the batteries in the cabinet and check if the FACP can self-test. Then follow the steps below.

- ✧ Check if the digital displays showing time are illuminated one by one.
- ✧ Check if the LCD showing system messages such as fire alarm is illuminated.
- ✧ Check if the LEDs showing the state of system can be illuminated one by one.
- ✧ Check if the LEDs showing the device state on ZCP are illuminated in turn.
- ✧ Check if the speaker can give loud alarm sounds.

### 4.4 Connection of Peripheral Devices

#### 4.4.1 Connection of Mains Power

Connect the FACP to mains power according to Fig. 4-2a.

- ✧ GST200N Series Fire Alarm Control Panel receives power from a 100-240VAC, 50-60Hz supply.
- ✧ The incoming power feed cable Earth (Green/Yellow) wire should be connected to the earth terminal.
- ✧ Connect the live wire to terminal L and connect the neutral wire to terminal N.

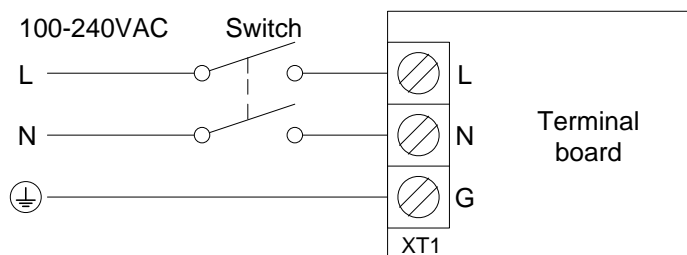
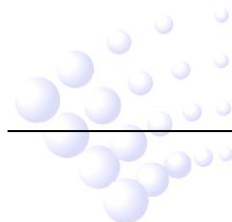

Fig. 4-2a



**Note:**

- 1) Do not power the system until the installation is completed.
- 2) The incoming mains cabling to the FACP should be supplied via an air switch to facilitate servicing.

**4.4.2 Connection of Batteries**

Refer to the Standby Battery Calculations section for the size of the batteries required for a particular installation.

Connect the batteries according to Fig. 4-2b and then connect them to power management board XT2.

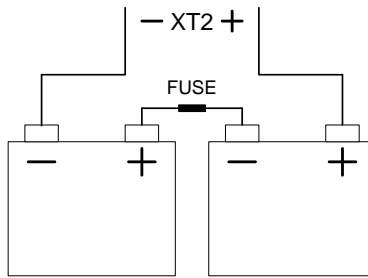

Fig. 4-2b



**Please note wiring polarity. Reverse connection will damage internal components of FACP. Do not make the final battery connections until installation is completed.**

**4.4.3 Connection of Peripheral Devices**

**Caution: Do not connect power to your device until you have completed all input and output connections. Failure to do so may result in injury!**

Terminals of loop interface board are shown in Fig. 4-3.

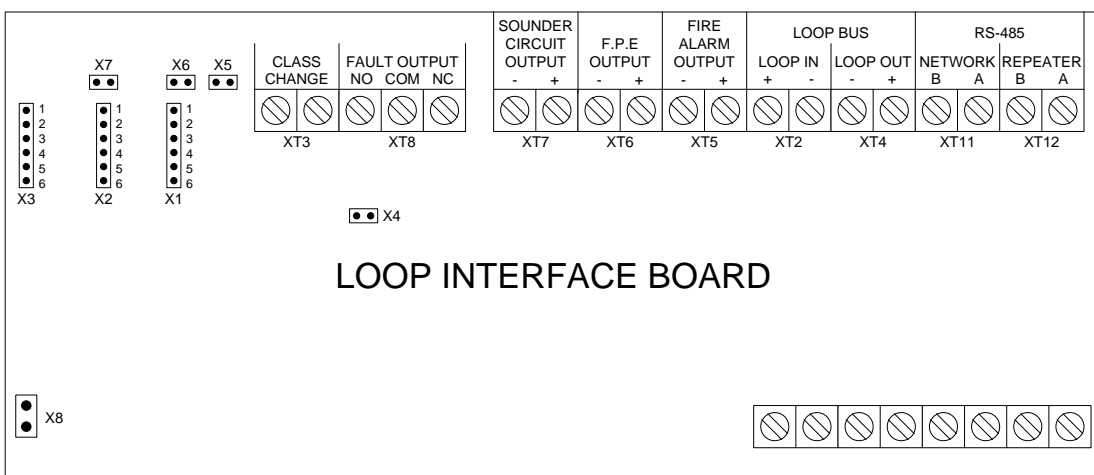
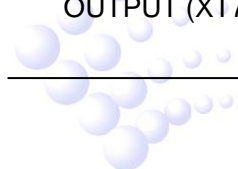

Fig. 4-3

**Description:**

- ✧ **CLASS CHANGE (XT3):** Shorting this terminal can enable SOUNDER CIRCUIT OUTPUT (XT7) to output.



- ✧ **FAULT OUTPUT (XT8):** Fault relay is closed in normal condition, and it's opened in fault condition.
- ✧ **SOUNDER CIRCUIT OUTPUT (XT7):** It outputs according to settings in Section 6.4.5 when there is fire alarm, which can be stopped by pressing *SILENCE* key on ZCP. Output can be disabled, and there is no output in disabled state. It can be included into C&E equation, and can be set at delay mode. The FACP will report fault when connected cable in short or open circuit.
- ✧ **F.P.E. OUTPUT (XT6):** It outputs according to settings in Section 6.4.5 when there is fire alarm. It can be disabled, and does not output when fire alarm occurs in disabled state. It can be included into C&E equation, but cannot be set at delay mode. The FACP alarms fault when connected cable in short or open circuit.
- ✧ **FIRE ALARM OUTPUT (XT5):** It outputs when there is fire and gives fault signals when connected circuit is short or open.
- ✧ **LOOP BUS (XT2, XT4):** Class A loop can connect with up to 235 addressable devices. With loop isolator in Class A loop, the detector protected by loop isolator is not missing when there is short or open circuit. In this case, the FACP reports loop fault.
- ✧ **RS-485 (XT11, XT12):** To be connected with repeater panel and FACP.
- ✧ **earth (X8):** This terminal is for checking earth fault when shorted.

F.P.E. OUTPUT, SOUNDER CIRCUIT OUTPUT and FIRE ALARM OUTPUT can provide three output modes, which are 24VDC voltage output, normally open output and normally closed output. You can set up the three modes through Pin X1 ~ X7. See more details in Table 4-1.

Table 4-1

Output	24VDC	Normally Closed	Normally Open
SOUNDER CIRCUIT OUTPUT	Short 1 to 2 & 4 to 5 of X3 Short X7	Short 3 to 4 & 5 to 6 of X3 Disconnect X7	Short 2 to 3 & 5 to 6 of X3 Disconnect X7
F.P.E. OUTPUT	Short 1 to 2 & 4 to 5 of X2 Short X6	Short 3 to 4 & 5 to 6 of X2 Disconnect X6	Short 2 to 3 & 5 to 6 of X2 Disconnect X6
FIRE ALARM OUTPUT	Short 1 to 2 & 4 to 5 of X1 Short X5	Short 3 to 4 & 5 to 6 of X1 Disconnect X5	Short 2 to 3 & 5 to 6 of X1 Disconnect X5

#### 4.4.3.1 Connection of SOUNDER CIRCUIT OUTPUT

Connection of SOUNDER CIRCUIT OUTPUT is shown in Fig. 4-4.

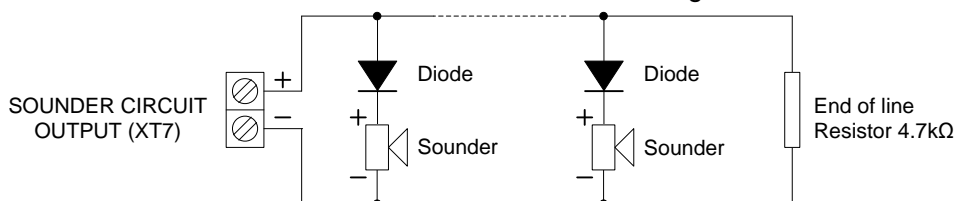

Fig. 4-4

A 4.7kΩ resistor is connected at the SOUNDER CIRCUIT OUTPUT (XT7) as factory



default. Please remove it and keep it well before connection. Connect the loop in correct polarity and add the resistor to the end of the line.

**NOTE: The sounder strobes are polarity-sensitive. Note polarity in connection. The maximum current of the circuit depends on the number of sounder strobes. Do not overload.**

#### 4.4.3.2 Connection of F.P.E. OUTPUT

F.P.E. OUTPUT is shown in Fig. 4-5.

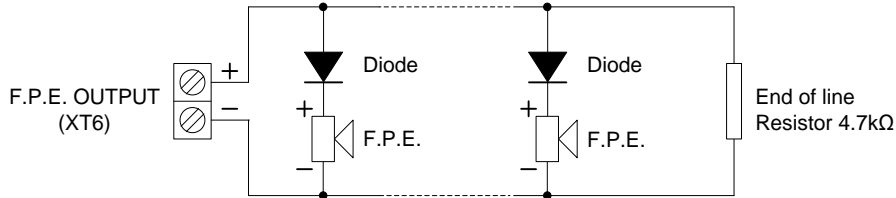

Fig. 4-5

A 4.7kΩ resistor is connected at the F.P.E. OUTPUT (XT6) as factory default. Please remove it and keep it well before connection. Connect the loop in correct polarity and add the resistor to the end of the line.

**NOTE: F.P.E. are polarity-sensitive. Note polarity in connection. The maximum current of the circuit depends on the number of F.P.E. Do not overload.**

#### 4.4.3.3 Connection of FIRE ALARM OUTPUT

FIRE ALARM OUTPUT is shown in Fig. 4-6.

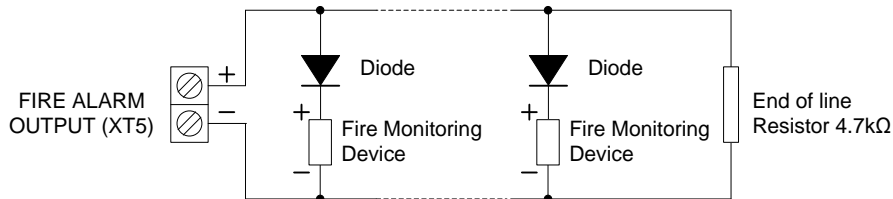

Fig. 4-6

A 4.7kΩ resistor is connected at the FIRE ALARM OUTPUT (XT5) as factory default. Please remove it and keep it well before connection. Connect the loop in correct polarity and add the resistor to the end of the line.

**NOTE: Fire supervisory devices are polarity-sensitive. Note polarity in connection. The maximum current of the circuit depends on the number of fire supervisory device. Do not overload.**

#### 4.4.3.4 Connection of Class A Loop

A Class A loop is shown in Fig. 4-7.

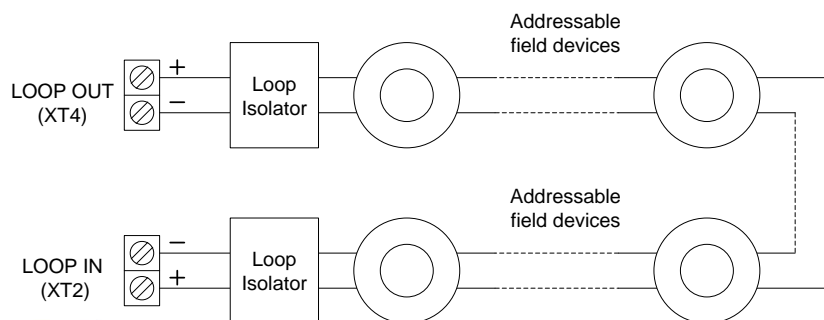

Fig. 4-7

**Note: If more than 32 devices are connected to the loop, loop isolators shall be**

**used and each loop isolator shall not cover more than 32 detectors.**

#### 4.4.3.5 Connection of 485 Communication Loop

Fig. 4-8 shows the connection of the FACP with repeater panels via 485 loop. An FACP can connect with maximum 10 repeater panels. The total communication length of the whole system shall not exceed 1200m.

A 485 loop can support a network of maximum 32 FACP's. The communication distance of the whole network shall not exceed 1200m if they are connected as in Fig. 4-9a. The distance between every two FACP's shall not exceed 1200m if they are connected as in Fig. 4-9b.

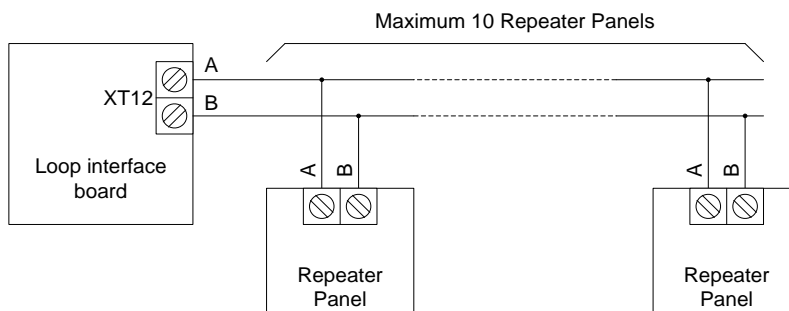

Fig. 4-8

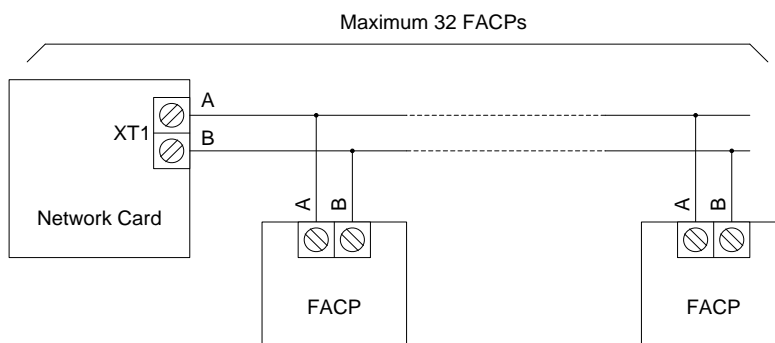

Fig. 4-9a

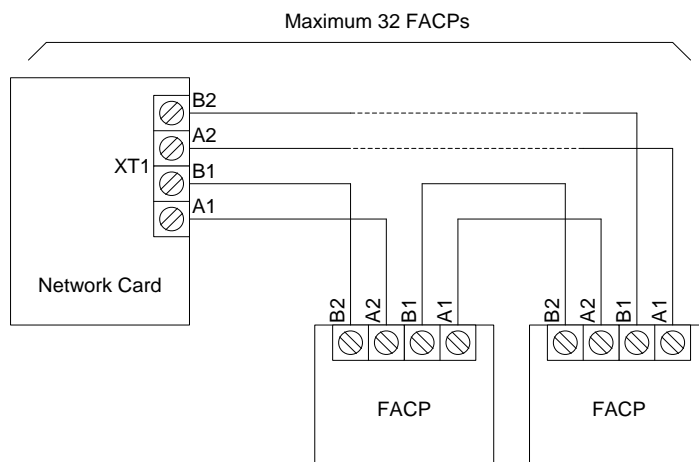

Fig. 4-9b

#### 4.4.3.6 Connection of CAN Loop

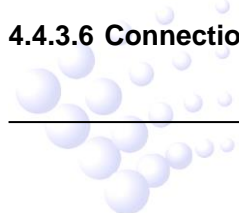

Fig. 4-10a shows the connection of a CAN network. It can support maximum 110 FACPs. The total communication distance of the whole network shall not exceed 3000m. If relays are used, a CAN network can be expanded to support maximum 240 FACPs. The distance between an FACP and a relay or between two relays shall not exceed 3000m. Fig. 4-10b shows the connection of a Class A CAN network. Maximum 240 FACPs can be connected in this type of loop. The distance between every two FACPs shall not exceed 1000m.

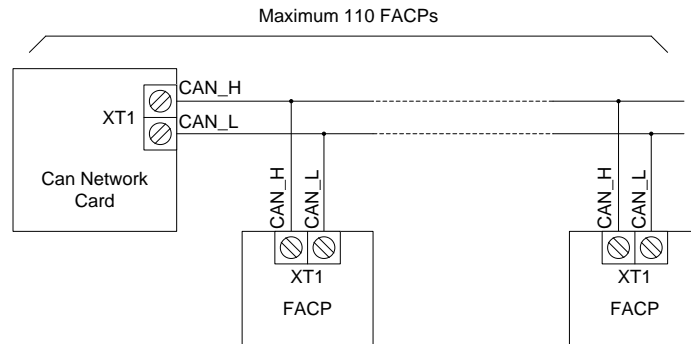

Fig. 4-10a

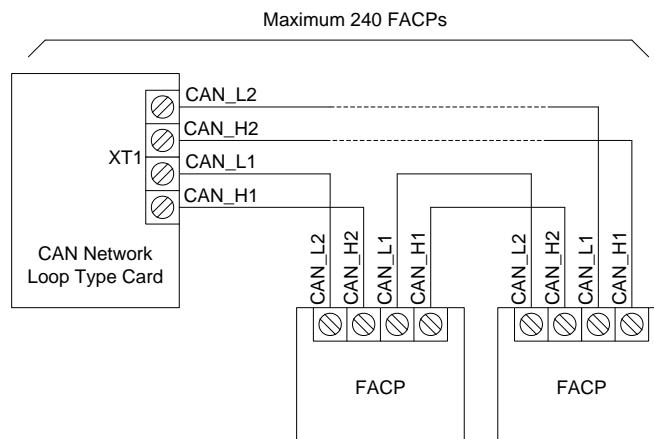

Fig. 4-10b

## 4.5 Connection Checking and Device Registration

### 4.5.1 Connection Checking

Check the circuit connected with the FACP. Measure the insulation resistance between loops and between loops and ground, which should be more than 20MΩ. Measure the load of detection loops, which should be more than 1kΩ. The resistance between cables of FIRE ALARM OUTPUT, SOUNDER CIRCUIT OUTPUT and F.P.E. OUTPUT should be equal to the end-of-line resistance.

### 4.5.2 Device Registration

Press *SYSTEM* and input commission password. Then press *ENTER* to go to system setting menu. Then press *ESC* to exit system setting menu, the system enters commission state (there will be a "-" at the right bottom of the screen). Rebooting the FACP will register the devices automatically. Please check if the number of devices, programming, and operation state is in compliance with the project design and remove

any problems.

#### **4.6 Device Definition**

Please define devices and C&E equations by the software Defining Tool through a PC, and download the definitions to the FACP. Refer to *GstDefx.x Defining Tool User's Manual* for detailed operation.

#### **4.7 Field Device Commission**

After connection, definition and download of device and C&E equations, you can power up the FACP and start commission. The following steps are for reference.

- 1 Complete the labels of ZCP.
- 2 Test all the detectors and make sure their positions are correct.
- 3 Check all device definition, and modify improper part.
- 4 Check all C&E equations, modify improper parts, and test automatic activation by C&E equation.

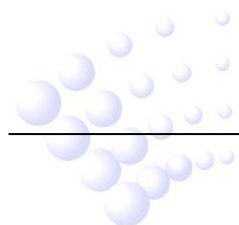

## Chapter 5 Display and Disposal of System Information

GST200N can be started after installation according to description in Chapter 4. Turn on the power supply, and then turn on the internal mains switch and plug in the battery terminals. The FACP executes self-test and enter normal standby state. The system will display properly if it is in normal state, otherwise it will display abnormal information.

### 5.1 Normal Information

The normal display is shown in Fig. 5-1, which means the system is in working state. Then only *POWER ON* LED lights.

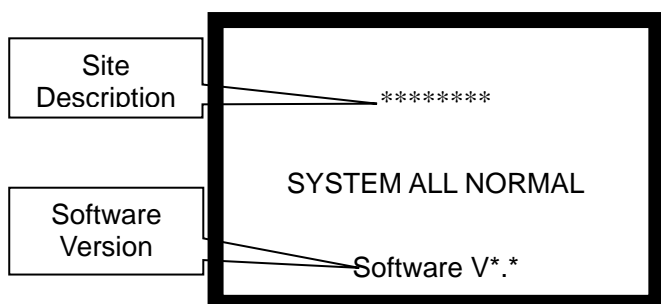

Fig. 5-1

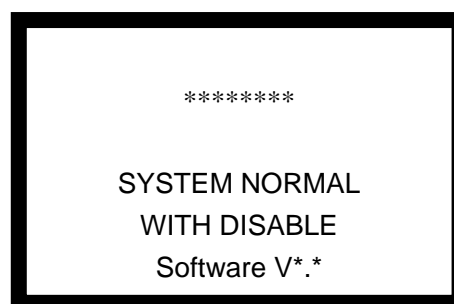

Fig. 5-2

Fig. 5-2 shows the system is in normal operation but with disabled devices. Pressing *VIEW DISABLE* can browse these devices.

### 5.2 Fire Alarm

#### 5.2.1 Fire Alarm Screen

*FIRE* LED is lit when there is fire alarm signal. Speaker of the FACP generates fire alarm sound (tick sound, 0.25s on, 0.25s off), and corresponding *FIRE* LED on the ZCP is also lit.

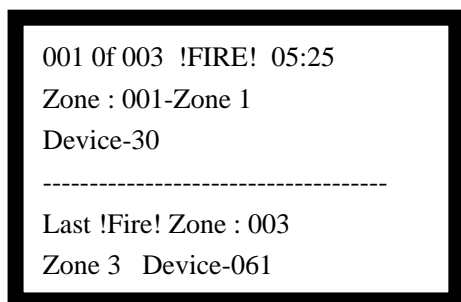

Fig.5-3

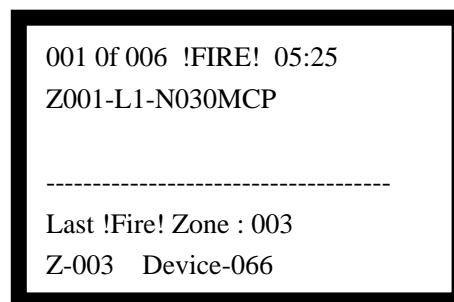

Fig. 5-4

1. Fig. 5-3 shows fire alarm screen in zone display mode.

- ◇ 001 Of 003 !FIRE! 05:25 // There are fire alarms in three zones and this is the first.
- ◇ Zone: 001-Zone 1 // The number of zones with fire alarm and description of the zone.
- ◇ Device-30 // The description of the device with the first fire alarm signal.
- 
- ◇ Last !Fire! Zone:003 // Zone number of the last fire alarm.

◇ Zone 3 Device-061 //Description of zone with the last fire alarm and description of the device of that zone with the first fire alarm.

2. Fig. 5-4 shows fire alarm screen in loop display mode.

◇ 001 Of 006 !FIRE! 05:25 // There are six devices with fire alarm signals, and this is the first.

◇ Z001-L1-N030MCP // The number of zone with fire alarm and type and address of the device in fire alarm.

-----  
◇ Last! Fire! Zone:003 //Number of the zone where the last fire alarm occurs

◇ Z-003 Device-066 // Description of zone and device of the last fire alarm.

### 5.2.2 Disposal of Fire Alarm Signal

When fire alarm occurs, first find out the location according to the information shown on the FACP to verify whether the fire really happened.

If it's a real fire, please take corresponding measures as outlined below.

**Step 1:** Evacuate people from the site.

**Step 2:** Call fire department.

**Step 3:** Turn on extinguishing equipment.

If it is a false alarm, please take the following measures.

**Step 1:** Press *SILENCE* to stop the sound.

**Step 2:** Remove the causes of the false alarm.

**Step 3:** Press *RESET* to make the FACP back to the normal state. If the device still gives false alarm, disable it and inform the installer or manufacturer for repair.

## 5.3 Fault

### 5.3.1 Fault Indication

The indication of the fault message depends on the type of fault. Specific fault types and causes are shown in Appendix 2.

◇ Power fault: If the AC power is down and the battery voltage is less than 19.5V, or if there is charging fault, the panel reports power fault, and

- Light *COMMON FAULT* and *POWER FAULT* LED.
- The LCD displays the type of the fault.
- The panel generates fault sound (tick sound, 1s on, 1s off).
- Fault relay outputs.

◇ System fault: The panel would report system fault if its control CPU and circuits is in fault and the panel cannot work normally.

- It lights the *COMMON FAULT* and *SYSTEM FAULT* LED.
- There is no display on the LCD.
- The panel generates system fault sound (continuous tick sound).
- The panel cannot monitor fire alarm.

- The keypad cannot be used.
- If system fault indication remains for less than 5 seconds, the panel will assume that this is not a true fault and automatically clear the LED and sounder indication and return to normal monitor state. If system fault indication remains for more than 5 seconds, the panel will then interpret it as a genuine fault and the LCD displays “System fault must be reset manually. System time must be reset.” after it’s cleared. You need to press *RESET* key to clear the fault indication and reset system time.
- Fault relay outputs.
- ✧ Keypad fault: The panel reports keypad fault if its keypad circuit is in fault:
  - It lights the *COMMON FAULT* and *SYSTEM FAULT* LED.
  - The LCD displays “Key fault”.
  - The panel generates system fault sound (continuous tick sound).
  - Fault relay outputs.
  - The keypad cannot be used.
  - The panel can monitor fire alarm.
  - The panel can reset automatically after the fault is removed.
- ✧ System device fault: If there is trouble with one of the devices in the system, the panel reports fault with it, and
  - The panel lights the *COMMON FAULT* LED.
  - The corresponding ZCP LED flashes.
  - The panel generates fault sound (tick sound, 1s on, 1s off).
  - Fault relay outputs.
  - The LCD displays the fault message. The fault screen is as in Fig. 5-5 in zone display mode, and as in Fig. 5-6 in loop display mode.

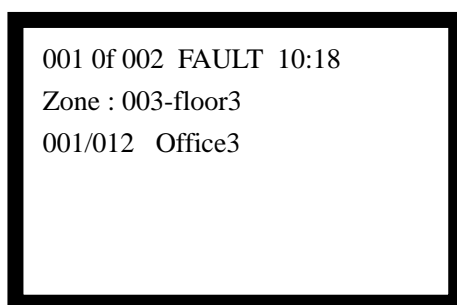

Fig. 5-5

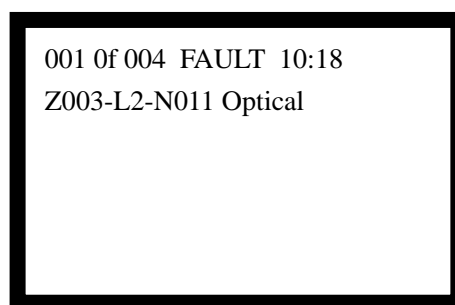

Fig. 5-6

In Fig. 5-5:

- 001 Of 002 FAULT10:18 // There are two zones reporting fault, and this is the first fault message.
- Zone: 003-floor3 // The number description of the zone with fault message.
- 001/012 Office3 //There are 12 devices in the zone totally, and one of them reports fault.

In Fig. 5-6:



- 001 Of 004 FAULT10:18 // There are four devices reporting fault, and this is the first fault message.
- Z003-L2-N011Optical // The number of the zone and loop with the fault message, and the address and type of the device with the fault message.

### 5.3.2 Disposal of Fault Message

There are two types of fault message. One is system fault, such as power fault and loop fault. The other is system device fault, such as fault with detectors and modules etc.

- ✧ If the system is powered by battery longer than the time its capacity allows, the panel will shut down to protect the battery. Please charge the battery in time to avoid any possible damage to it.
- ✧ If it is system fault, please check and repair the panel in time. If the panel needs to be shut down, please take detailed notes.
- ✧ If it is system device fault, please repair the device in time. You can disable it if the fault can't be cleared for some reason, and enable it when the fault is removed.

### 5.4 Rules for Message Display

If there are multiple messages in the system, they will be displayed in the following order: fire alarm, fault, action, disable.

- 1 The earliest fire alarm is displayed in priority. The latest fault, action, disabled message is displayed in priority.
- 2 There are zone and loop display modes for fire alarm, fault, and disabled messages. Action message only has loop display mode.
- 3 In any display mode, the system will return to displaying of the highest priority if there is no operation within 20s (15s ~ 30s).

### 5.5 Rules for Sound Indication

The FACP will sound to indicate fire alarm or fault messages.

- ✧ The FACP gives fire alarm sound when fire alarm occurs – tick sound, 0.25s on, 0.25s off.
- ✧ Delayed activation of devices by automatic C&E equation – tick sound, 0.5s on, 0.5s off.
- ✧ The FACP gives fault sound when fault occurs – tick sound, 1s on, 1s off.

The FACP will give sound of higher priority if two or more types of event occur simultaneously.

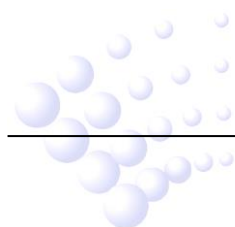

## Chapter 6 Description of System Operation

### 6.1 Keypad

#### 6.1.1 Keypad Functions

Most of the keys have double functions. Lower mark is a character and upper mark is a command that is only activated in monitoring state. Most functional keys are controlled by password. The characters are only active after entering the menu. Pressing *ESC* will return to previous level of the menu.

#### 6.1.2 Methods of Data Input

Pressing a character key, all characters disappear, and the display shows the newly input one. The cursor will indicate the next input position (The cursor always indicates the position of the next to input, and returns to the first character after completion of a line). Pressing  $\underline{\Delta}$  or  $\overline{\nabla}$ , to move the cursor to modify any character.

Pressing *TAB*, the highlight moves to the next position and returns to the first after the last position. Wherever the cursor is, Pressing *ENTER* key, all the input data will be saved.

If there is no keypad operation for over 1 minute, the system will exit present state without saving the input data.

#### 6.1.3 Unlocking and Locking the Keypad

##### ✧ Unlocking the Keypad

The FACP is locked by default when powered up. If some operations are needed, the LCD will display a screen requiring proper password. Entering the correct password and pressing *ENTER*, you can continue to operate, as the keypad is unlocked. See Fig. 6-1.

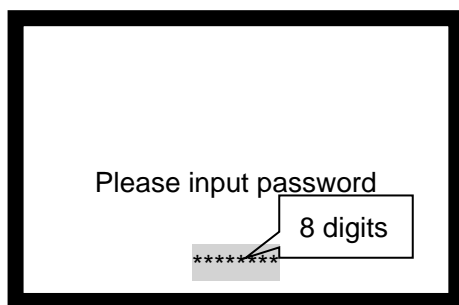

Fig. 6-1

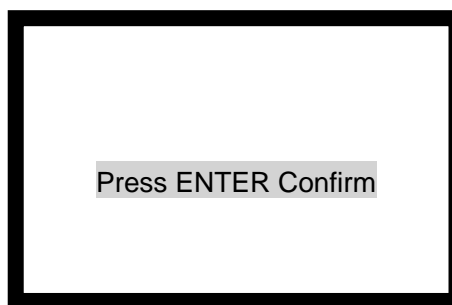

Fig. 6-2

##### ✧ Locking the Keypad

The keypad shall be locked after an operation or when the personnel on duty leave. Pressing *LOCK*, the screen will display "**Press ENTER confirm**" like in Fig. 6-2. Pressing *ENTER*, the keypad is locked. You will have to input password again to unlock the keypad for any new operation.

### 6.2 User Operation Instruction (No Password Requirement)

#### 6.2.1 Changing displayed time

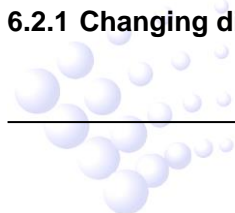

The clock usually displays in hour and minute. In normal monitoring state, pressing *ENTER*, month and date are displayed. Pressing *ENTER* again or after a minute, hour and minute is displayed again.

## 6.2.2 Browsing messages

### 6.2.2.1 Turning pages

You can look through information one by one by pressing  $\Delta$  and  $\nabla$ .

### 6.2.2.2 Browsing more than one piece of message

The current information is highlighted when there is more than one piece of message on the LCD. You can view details of this item by pressing *ENTER* or exit by pressing *ESC*. When the printer is set as "All History" mode, pressing *ENTER* while browsing can print the current displayed message.

### 6.2.2.3 Browse

Pressing *BROWSE*, the system enters the browsing screen as shown in Fig. 6-3.

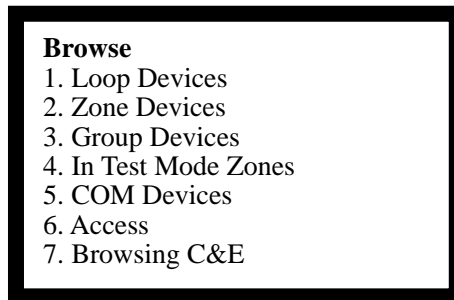

Fig. 6-3

From the above screen, you can operate as follows:

- ✧ Entering number 1 to choose "1. Loop Devices" will enter the screen to view devices by loop, as shown in Fig. 6-4.

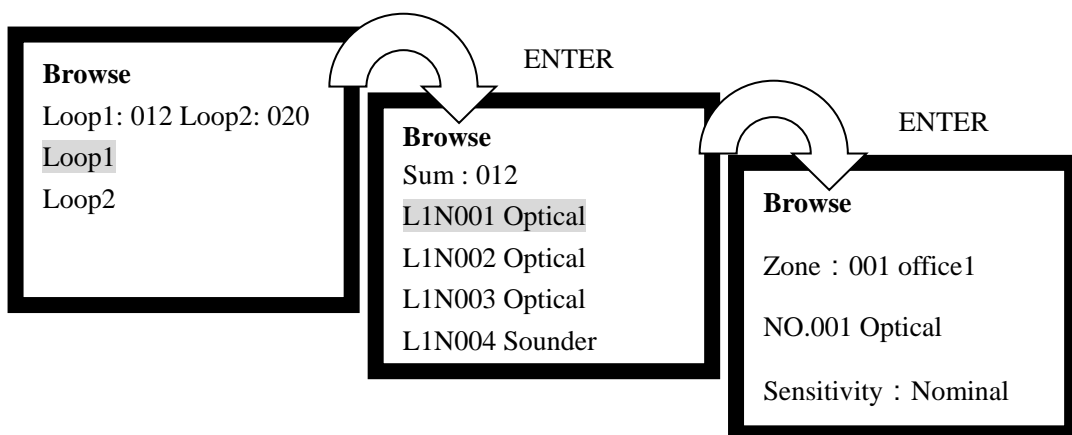
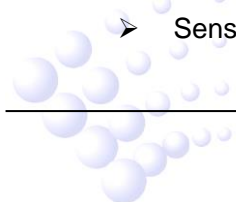

Fig. 6-4

- L1N001 Optical // Loop number, device address and device type.
- Zone: 001 office1 // Zone number, and zone position description.
- NO.001 Optical // Device address, device type.
- Sensitivity: Nominal // Device properties.



- Office1// Device position description.

✧ Entering No. 2 will enter the screen for browsing loop devices by zone, as in Fig. 6-5.

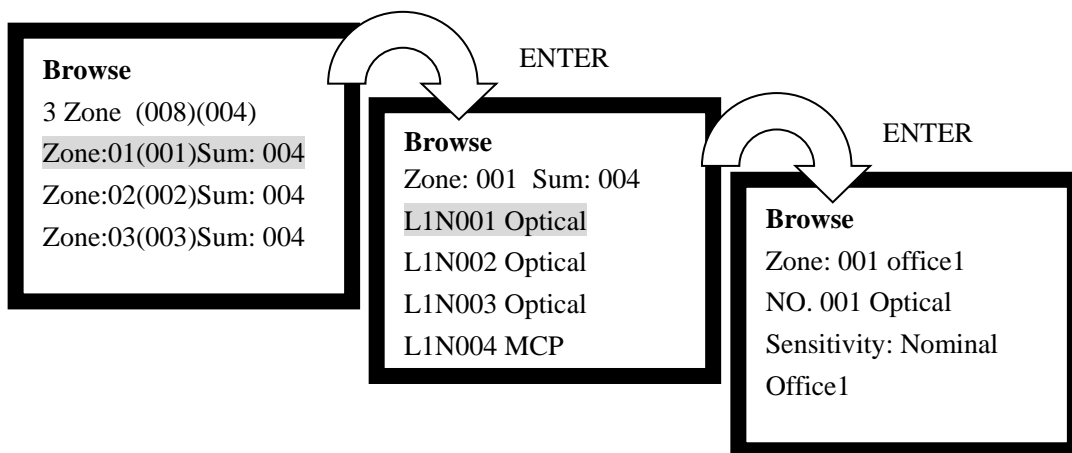

Fig. 6-5

- 3 Zone (008)(004) // 3 zones in total, 8 addressable devices on Loop 1, and 4 on Loop 2
- Zone:01(001)Sum:004 // Zone 01, (001) is the zone number with starting zone added, total number of devices is 4.
- Zone: 001 office1 // Zone number and location
- NO.001 Optical // Device address and type
- Sensitivity : Nominal // Device properties
- Office1// Device position

✧ Entering number 3 to choose “3. Group Devices” will enter the screen for browsing devices by group, as shown in Fig. 6-6.

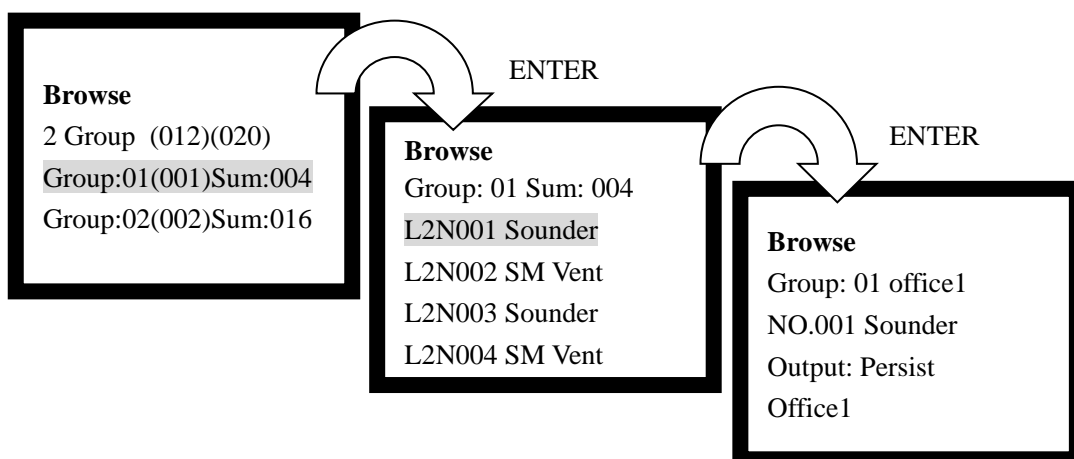
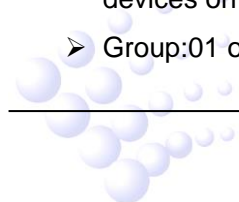

Fig. 6-6

- 2 (Group) (012)(020) // 2 groups are defined. There are 12 addressable devices on Loop 1, and 20 on Loop 2.
- Group:01 office 1 // Zone number and location of the zone



- NO. 001 Sounder //Device address and type
- Output: Persist // Device properties
- Office 1 // Device location
- ✧ Entering number 4 to choose “4. In Test Mode Zones” will enter the screen for browsing zones in test mode, as shown in Fig. 6-7.

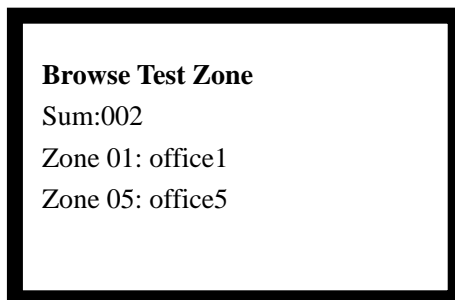

Fig. 6-7

In Fig. 6-7:

- Sum:002 // Total number of zones in test
- Zone 01: office1 // Zone 1 is in test mode. Zone description is “office1”.
- Zone 05: office5 // Zone 5 is in test mode. Zone description is “office5”.
- ✧ Entering number 5 to choose “5: COM Devices” will enter the screen for browsing network FACP’s and repeater panels.
- ✧ Entering number 6 to choose “6. Access” will enter the screen for browsing ZCP key definition, as in Fig. 6-8.

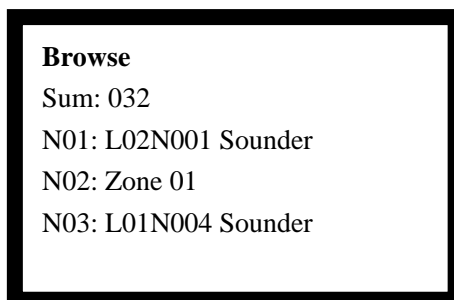
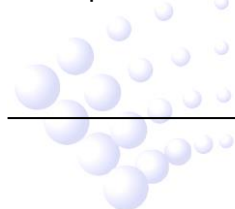

Fig. 6-8

- Sum: 032 // Total number of keys on ZCP
- N01: L02N001 Sounder // Key No. 1 is defined as a sounder of Loop 2 whose address is 001.
- N02: Zone 01 //Key No. 2 is defined as Zone 1 indicator
- N03: L01N004 Sounder //Key No. 3 is defined as a sounder of Loop 1 whose address is 004.
- ✧ Entering No. 7 to choose “7: Browsing C&E” will enter the screen for browsing C&E equation, as shown in Fig. 6-9.



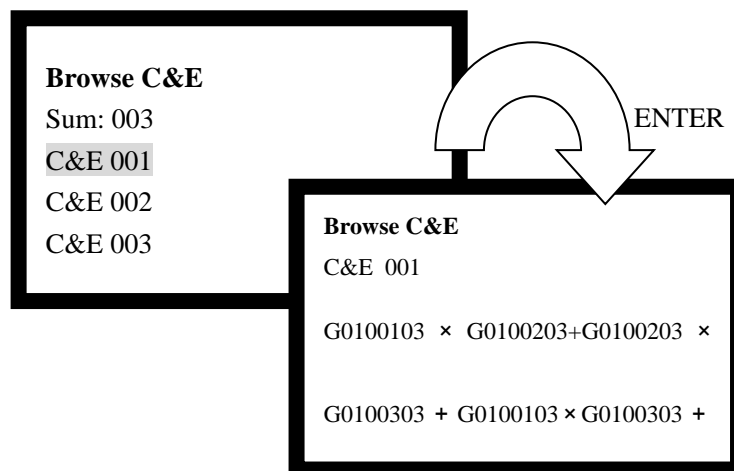
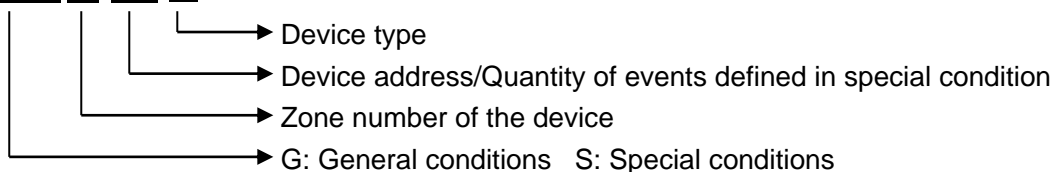

Fig. 6-9

- The part before “=” is the condition and that after it is the result.
- “x” means “and”, and “+” means “or”.
- A condition is composed of the following items:

G(S) 01 001 03



**General Condition:** A device can be activated if its zone number, code and device type are correct.

**Special Condition:** Both zone number and device type can be defined. If events with the same zone number and device type reach a defined number, this special condition comes into effect. Asterisk wildcard “\*” represents any number used in special conditions.

**Event:** It is the message generated by the FACP when there is fire alarm or action of device.

- ✧ A result is composed of the following items.

01 004 13 00

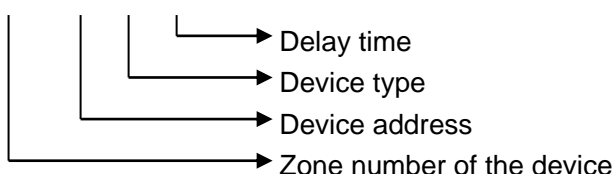

#### 6.2.2.4 Browsing history log

Pressing LOG, the FACP enters the state of browsing history record. The screen is shown in Fig. 6-10.

- ✧ Inputting number “1” chooses “1 History Record” and enters the screen shown as Fig.

6-11 .Using  $\triangle$  and  $\nabla$ , you can browse every item.



Fig.6-10

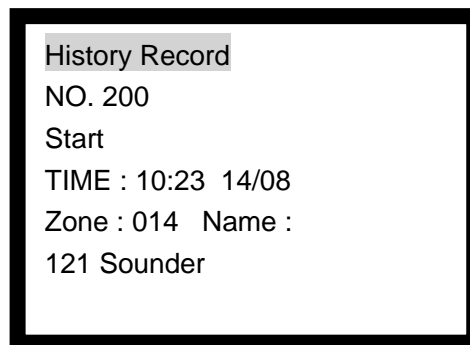

Fig. 6-11

In Fig.6-11,

- NO. 200 // The two hundredth history log
- Start // Starting message
- TIME: 10:23 14/08 // Date and time of the event
- Zone: 014 Name : // Zone number, zone name
- 121 Sounder // Device address and type

✧ Inputting number “2” chooses “2 Fire Record” and enters the screen shown as Fig.

6-12 .Using  $\triangle$  and  $\nabla$ , you can browse 500 fire records at the latest.

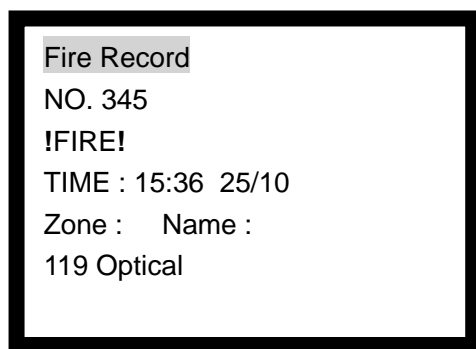

Fig. 6-12

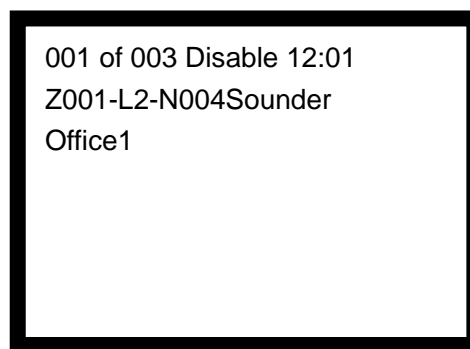

Fig. 6-13

In Fig. 6-12,

- NO. 345 // The 345th fire alarm log
- !FIRE! // Fire message
- TIME: 15:36 25/10 // Date and time of the event
- Zone: 011 Name: // Zone number, zone name
- 119 Optical // Device address and type

### 6.2.2.5 Browsing fault messages

You can view fault messages by pressing *VIEW FAULT* when the screen is displaying

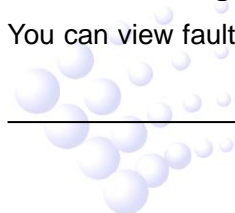



non-fault messages. The display varies by the type of fault messages. Please refer to Section 5.3.

#### 6.2.2.6 Browsing disable messages

You can view disable messages by pressing *VIEW DISABLE* when the screen is displaying non-disable messages. The screen of loop mode is shown in Fig. 6-13 and the screen for zone mode is shown in Fig. 6-14 and Fig. 6-15.

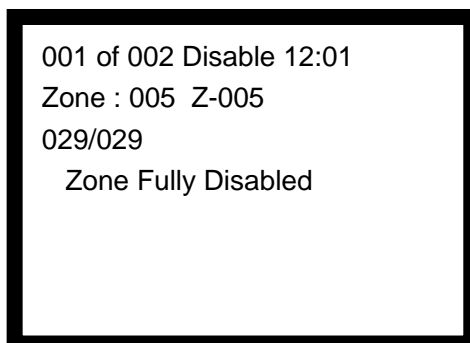

Fig. 6-14

- ✧ 001 of 002 Disable 12:01 // There are devices from 2 zones that are disabled, and this is the first zone.
- ✧ Zone: 005 Z-005 // Zone number and description message of the disabled zone.
- ✧ 029/029 // All 29 devices of the current zone are disabled.
- ✧ Zone Fully Disabled // Current zone are completely disabled.

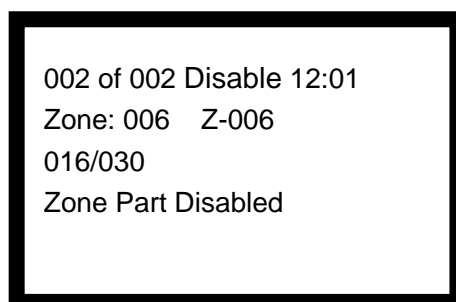

Fig. 6-15

- ✧ 002 of 002 Disable 12:01 // There are devices from 2 zones that are disabled , and this is the second zone.
- ✧ Zone: 006 Z-006 // Zone number and description message of the disabled zone.
- ✧ 016/030 //There are 16 disabled devices in all 30 devices of the current zone.
- ✧ Zone Part Disabled // The zone is partially disabled.

#### 6.2.3 Silencing the panel

Pressing *ACK/MUTE* can stop the sound of speaker; pressing *ACK/MUTE* again, the FACP is still in mute state. It will only sound by priority when new event appears.

### 6.3 Instructions for Operator (Operator Password Required)

### 6.3.1 Resetting the system

Pressing *RESET* can turn off all the control modules, local outputs and reset all the detectors, but will leave the disabled devices as they are. The LCD displays “RESET IN SYSTEM”. LEDs will be turned off (Except for “POWER ON”, “TEST MODE”, “DELAY MODE” LEDs). The reset information will be written into running log. If there is still fire alarm, fault and action not acknowledged after pressing the *RESET* key, the FACP will remain relative sound indications. If all messages have been acknowledged by pressing *RESET* key, the system returns to normal display state.

### 6.3.2 Alarm Silence

Pressing *SILENCE* key can silence all sounders in the system, and light the *SILENCE* indicator.

The silenced sounders will re-sound on receiving new alarms. *SILENCE* indicator will go out when *RESET* key is pressed for reset, when *EVAC* key is pressed for evacuation, or when system sounders gives new alarm sound.

### 6.3.3 Evacuation

Pressing *EVAC* key can start all system sounders, and light *EVACUATE* LED until *SILENCE* or *RESET* key is pressed. After *EVAC* key is pressed and password is entered, the LCD will display “*EVACUATE IN SYSTEM Press ENTER confirm*”. Pressing *ENTER* in 10 seconds will start evacuation. If *ENTER* key is not pressed in 10 seconds, the FACP will resume the state before *EVAC* key is pressed.

### 6.3.4 Disable/Enable

The disabling/enabling of devices is mainly used when the trouble condition of a device cannot be removed immediately. This device can then be temporarily disabled, and enabled after it's repaired.

The disabling/enabling of alarm output can be set as needed either to start or not to start *SOUNDER CIRCUIT OUTPUT* and *FPE OUTPUT* automatically.

The disabling/enabling of delay can be set as needed. For example, if there is person on duty, the system delay can be enabled, so that the system can select delay by C&E equation or by the pre-set default local delay in case of an alarm. If there is nobody on duty, the delay can be disabled and the system outputs immediately.

Pressing *ENABLE/DISABLE*, the screen will be shown as in Fig. 6-16.

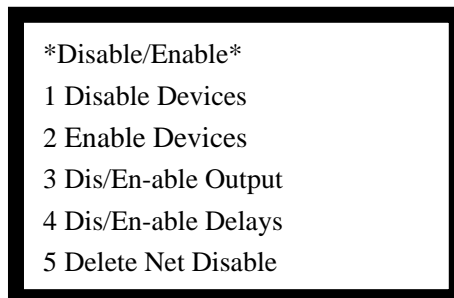
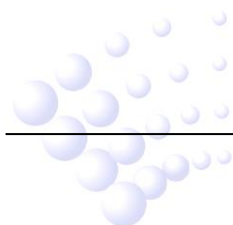

Fig. 6-16



### 6.3.4.1 Disabling a Device

In the screen shown in Fig. 6-16, input number “1”, you can enter disable screen as shown in Fig. 6-17, where you are able to disable devices. The panel provides four methods for disabling devices. You can disable all devices of a zone, a single device (single-device disable) , disable all loop sounders, or disable a device by user code.

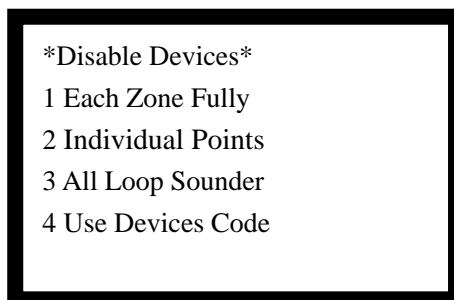

Fig. 6-17

#### ✧ Disabling a zone

Entering number “1” in the screen of Fig. 6-17 will enter disable screen as shown in Fig. 6-18. Entering 3-digit zone number and Pressing *ENTER* key to confirm will disable all devices of the zone.

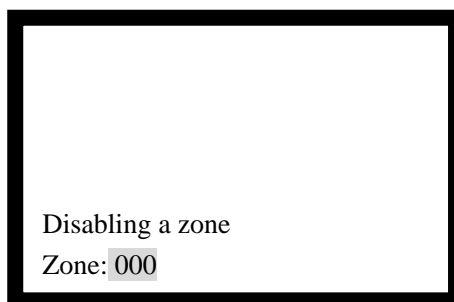

Fig. 6-18

#### ✧ Disabling a point (device)

Entering number “2” in the screen of Fig. 6-17 will enter the screen for disabling a single device, as shown in Fig. 6-19. Entering 1-digit loop number (1 or 2) and 3-digit point number (any number between 1 to 242), and then pressing *ENTER* will disable the selected device.

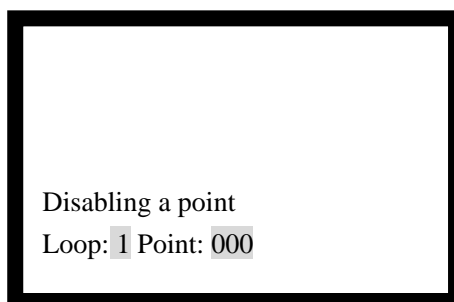
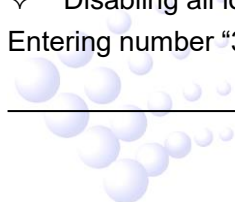

Fig. 6-19

#### ✧ Disabling all loop sounders

Entering number “3” in the screen of Fig. 6-17 will enter the screen for disabling all loop



sounders, as shown in Fig. 6-20. Pressing *ENTER* on prompt will confirm the operation and disable all loop sounders.

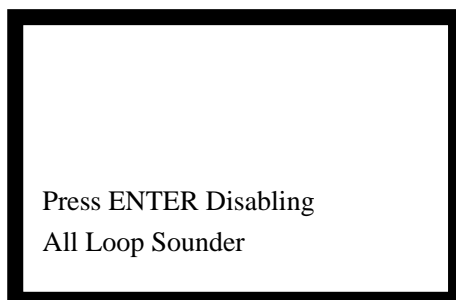

Fig. 6-20

✧ Disabling a device by user code

Enter number “4” in the screen of Fig. 6-17 will enter the screen for disabling a device by user code, as shown in Fig. 6-21.

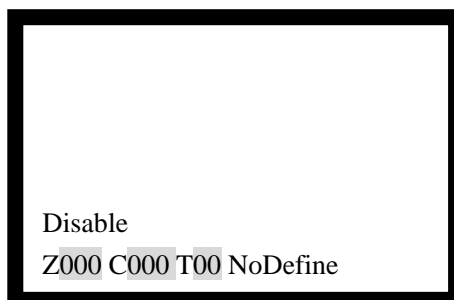

Fig. 6-21

Enter 3-digit zone number or “\*” at the cursor position after letter “Z”.

Enter 3-digit device code or “\*” at the cursor position after letter “C”.

Enter 2-digit device type or “\*” at the cursor position after letter “T”.

Example 1, in order to disable devices with type number 001 of Zone No.1, you need to input in sequence the zone number 001, device number 001 and device type 03.

Example 2, in order to disable all alarm devices with type number 01 ~ 11 of Zone No.1, you need to input in sequence the zone number 001, device code \*\*\* and device type \*\*.

Please note that the asterisk mark “\*” is not allowed for the type number of action devices with type number 12 ~ 65.

#### 6.3.4.2 Enabling Devices

In the screen shown in Fig. 6-16, input number 2, you can enter device enable screen as shown in Fig. 6-22. Same as disabling devices, you can also enable all devices of a zone, a single device (single-device enable), all loop sounders, or enable a device by user code.

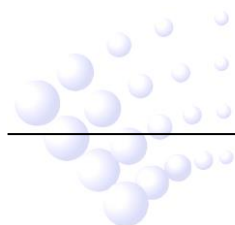
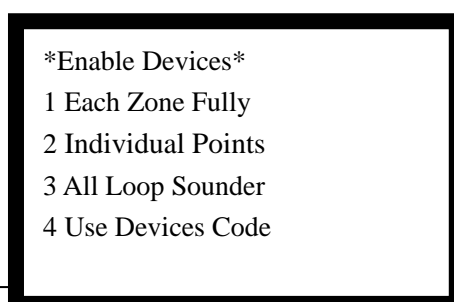

Fig. 6-22

#### 6.3.4.3 Disabling/Enabling Alarm Outputs

Entering number “3” in the screen of Fig. 6-16 will enter the screen for disabling/enabling alarm output, as shown in Fig. 6-23. In this screen, the SOUNDER CIRCUIT OUTPUT and FPE OUTPUT on the loop interface board can be disabled or enabled.

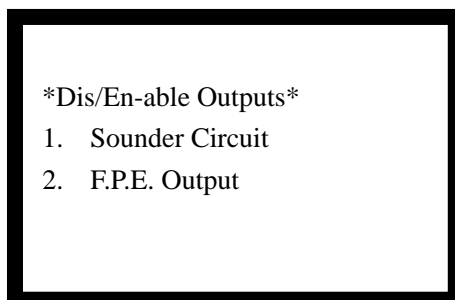

Fig. 6-23

#### 6.3.4.4 Disabling/Enabling Delays

Inputting number 4 in the screen shown in Fig. 6-16 can enter the screen of disabling/enabling delays, as shown in Fig. 6-24.

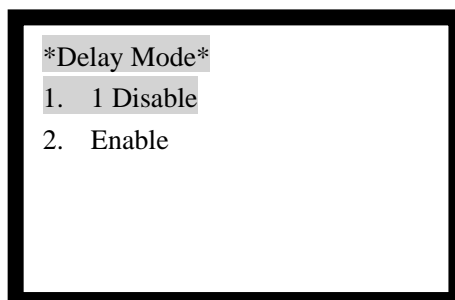

Fig. 6-24

In the above screen, you can operate as follows:

- ✧ Selecting number 1 will disable all delay settings in the system.
- ✧ Selecting number 2 will enable system to output according to the pre-set delay time, and light *DELAY MODE* LED.

**Note:**

- (1) If Delay Mode is enabled, sounders will output according to the C&E setting; if there is no delay set in C&E, sounders will output immediately. Refer to Section 6.4.5.1.2.
- (2) If Delay Mode is disabled, sounders will output immediately even if there are delay settings by C&E.
- (3) If the fire alarm is from a manual call point, then the system will output immediately despite any delay settings.

#### 6.3.4.5 Deleting Disabled Information in Network

Entering number 5 in the screen of Fig. 6-16 will enter the screen for deleting disabled information in network, as shown in Fig. 6-25. In this screen, entering the number of the message, and pressing *ENTER* to confirm will delete the disabled information from

network FACP.

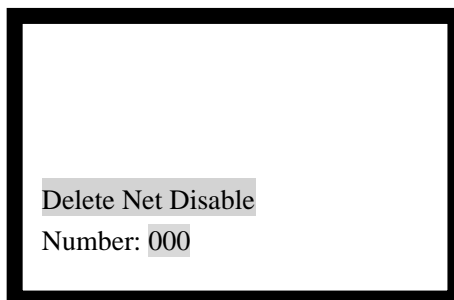

Fig. 6-25

### 6.3.5 User Mode

Pressing *MODE* key can enter user mode setup screen as shown in Fig. 6-26. In this screen, the user can setup the screen contrast, display mode, printing mode and pre-alarm mode, and can also start or stop devices.

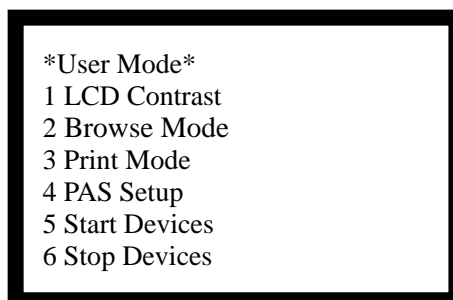

Fig. 6-26

#### 6.3.5.1 LCD Contrast Setup

Entering 1 in Fig. 6-26 will enter the screen for setting up LCD contrast, as shown in Fig. 6-27. In this screen, the contrast of LCD can be adjusted using " $\Delta$ " and " $\nabla$ " followed by *ENTER*.

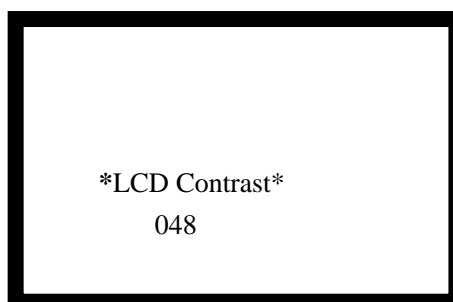
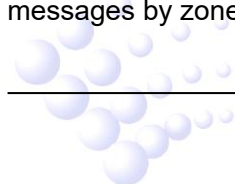

Fig. 6-27

#### 6.3.5.2 Display Mode Setup

Entering 2 in the screen of Fig. 6-26 will enter the screen for setting up display mode, as shown in Fig. 6-28. In this screen, choosing "1 Zone Mode" can browse system messages by zone, and choosing "2 Loop Mode" can browse by loop.



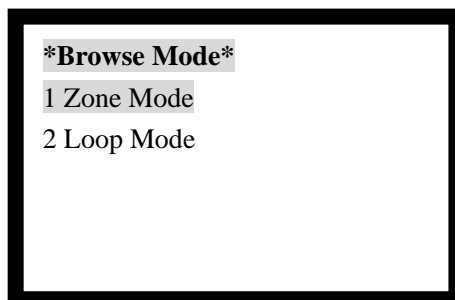

Fig. 6-26

### 6.3.5.3 Printing Mode Setup

Entering 3 in the screen of Fig. 6-26 will enter the screen for setting up print mode, as shown in Fig. 6-29.

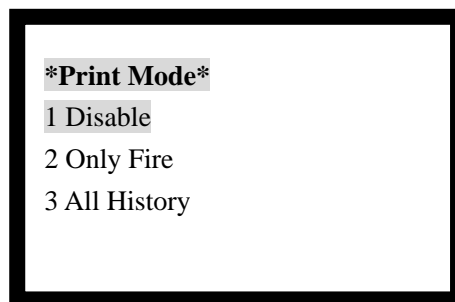

Fig. 6-29

Entering number “1” means printing is disabled.

Entering number “2” means only printing fire alarm message.

Entering number “3” means printing the currently viewed message when checking history records.

### 6.3.5.4 Positive Alarm Sequence (PAS) Setup

Entering 4 in the screen of Fig. 6-26 will enter the screen for setting up pre-alarm screen, as shown in Fig. 6-30.

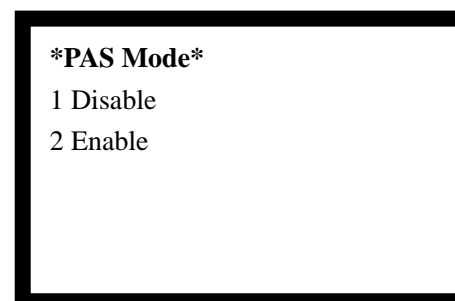

Fig. 6-30

If the panel is set to PAS mode enabled,

- ✧ On receiving the first fire alarm from a detector, *PRE-ALARM* LED will illuminate. The FACP generates fire alarm sound, and starts 15-second delay. The LCD displays pre-alarm message, indicating the position of the alarm and the remaining

delay time.

- ✧ During the 15-second delay time, if *ACK/MUTE* is pressed, the alarm sound will stop, and the delay time will be increased by PAS DELAY (0-180s) setup.
- ✧ After the delay of any stage expires, the pre-alarm will change to fire alarm and fire protection devices in the system will be started.
- ✧ During any stage of delay, if there is another detector of the same zone or any manual call point in the system alarms, the delay will be stopped, the pre-alarm will be changed to fire alarm, and fire protection devices in the system will be started.
- ✧ During the delay time, pressing *RESET* will clear the pre-alarm and PAS delay.

#### 6.3.5.5 Manual Start of Loop Device

Entering 5 in the screen of Fig. 6-26 will enter the screen for manual start of system devices, as shown in Fig. 6-31. The FACP provides two modes, starting a single device and starting multiple devices. The method of operation and the use of "\*" is the same as disablement.

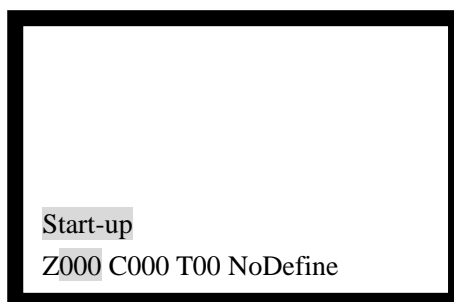

Fig. 6-31

#### 6.3.5.6 Manual Stop of Loop Devices

Entering 6 in the screen of Fig. 6-26 will enter the screen for manual stop of loop devices. The method for stopping a device is the same as starting a device.

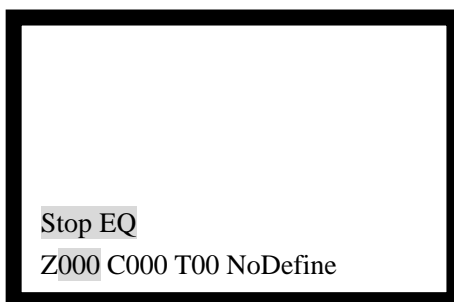

Fig. 6-32

#### 6.3.6 Device Start/Stop through ZCP

According to definition of the ZCP, press the key corresponding to a device, and input the requested password, you can start the device. Corresponding command LED of the key is lit. Press the key and input password again, you can stop the device, and the command LED turns off.

#### 6.3.7 Test Mode Setup

Pressing *TEST* can enter test mode setup screen as shown in Fig. 6-33.



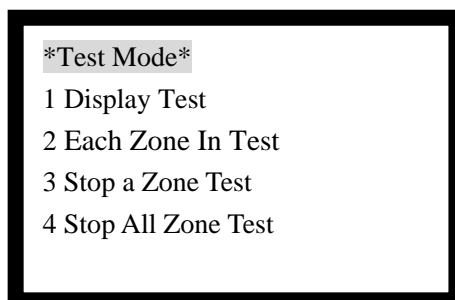

Fig. 6-33

In this screen, the user can carry out self-test on audible/visual performance, setting up single-zone testing, exiting single-zone testing mode and exiting testing of all zones.

#### 6.3.7.1 Audible/Visual Self-test

Entering 1 in the screen of Fig. 6-33, if the system is in normal standby state, the FACP will self-test all indicators and audible components.

#### 6.3.7.2 Single-zone Testing Setup

Entering 2 in the screen of Fig. 6-32 will enter the screen for setting up single-zone testing, as shown in Fig. 6-34.

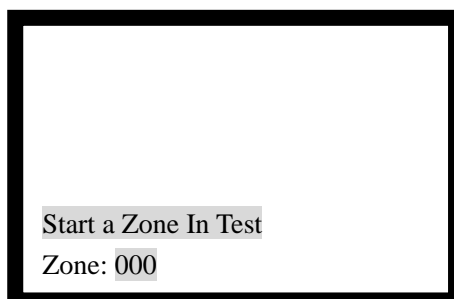

Fig. 6-34

Entering the zone to test in this screen and pressing *ENTER* to confirm, the zone will enter test mode, and the *TEST MODE* indicator will illuminate.

#### 6.3.7.3 Exiting Single-zone Testing Mode

Entering 3 in the screen of Fig. 6-33 will enter the screen for exiting single-zone test mode, as shown in Fig. 6-35. Entering the number of the zone to exit test mode and pressing *ENTER* to confirm will enable the zone to exit test mode.

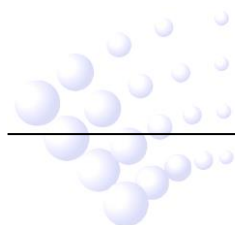
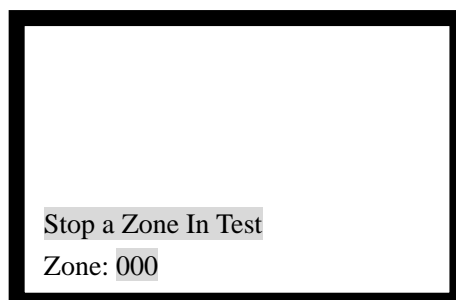

Fig. 6-35

#### 6.3.7.4 Exiting Test Mode for All Zones

Entering 4 in the screen shown in Fig. 6-33 will enter the screen for all zones to exit test mode, as in Fig. 6-36. After pressing *ENTER* for confirmation, *TEST MODE* indicator will go out.

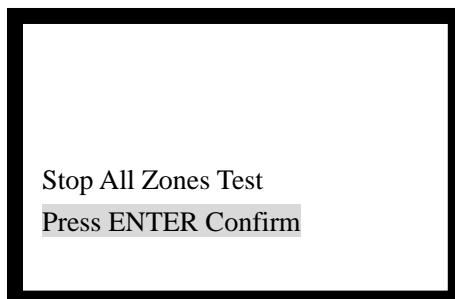

Fig. 6-36

### 6.4 Instructions for System Administrator (Manager Password Required)

Press *SYSTEM* to enter the system setting screen. The screen is shown in Fig. 6-37.

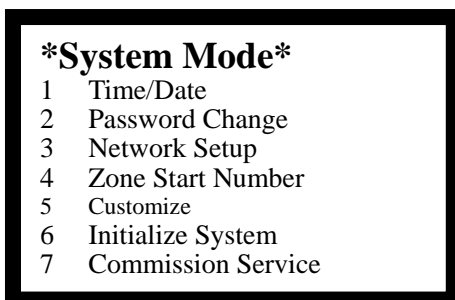

Fig. 6-37

#### 6.4.1 Modifying System Time

Entering "1" in the screen of Fig. 6-37, the system enters Time/Date setting screen, as shown in Fig. 6-38. After Entering time at highlighted position and press *TAB*, then the next cell is highlighted. Pressing *ENTER* will save the modification.

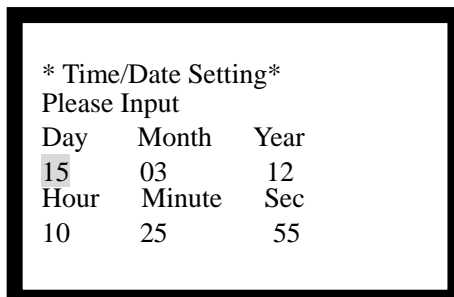

Fig. 6-38

#### 6.4.2 Modifying Password

Entering "2" on the screen in Fig. 6-37, the system enters the window for password modification, as in Fig. 6-39. Now the passwords can be modified. Entering "1" or "2"

can choose the password to modify, the system enters the window in Fig. 6-40.

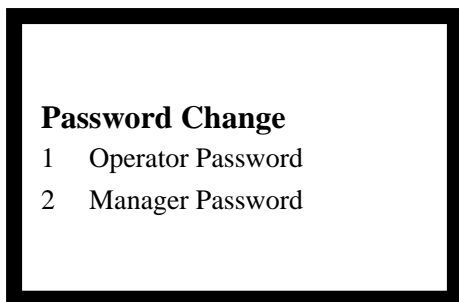

Fig. 6-39

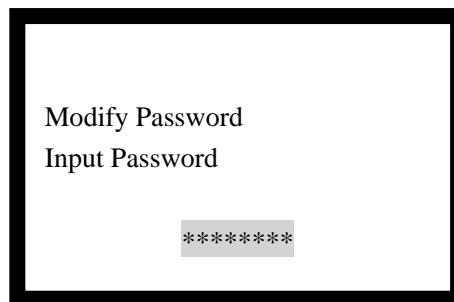

Fig. 6-40

After the password (8 digits from 0-9) is input, the LCD will display the screen shown in Fig. 6-41, requesting to confirm password. Entering the new password again, if the two passwords are the same, the LCD will display the window shown in Fig. 6-42, meaning the modification is successful.

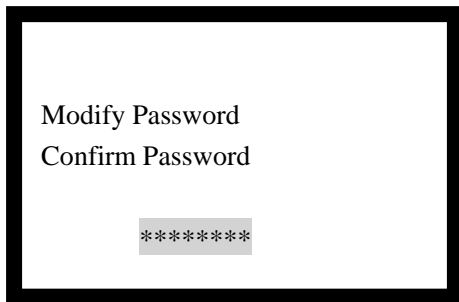

Fig. 6-41

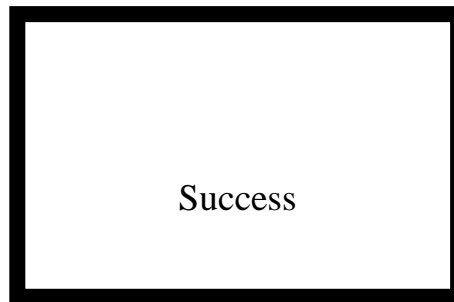

Fig. 6-42

### 6.4.3 Network Setup

Input "3" on the screen in Fig. 6-37, the screen shown in Fig. 6-43 will be displayed. In this screen, you can

- ◇ Set the panel's network address by entering number 1, as shown in Fig. 6-44. The address can be set to any number between 1 and 240.
- ◇ Set the panel to display network message or not by entering number 2, as shown in Fig. 6-45.

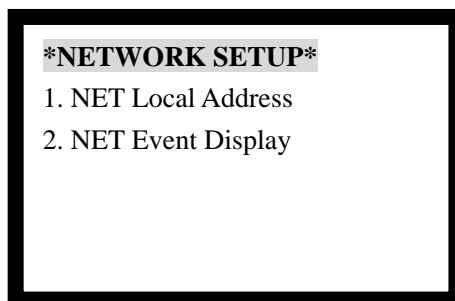
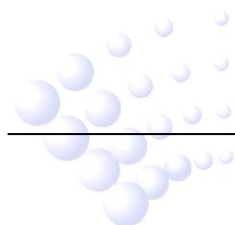

Fig. 6-43



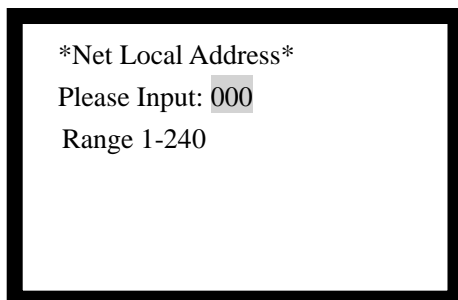

Fig. 6-44

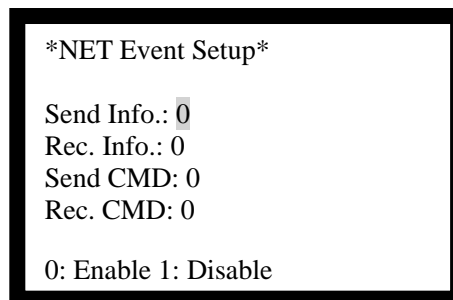

Fig. 6-45

#### 6.4.4 Setting up Beginning Zone Number

Pressing "4" on the screen shown in Fig. 6-37, you can set beginning zone number of the FACP in network. The screen is shown in Fig. 6-46. This setup is for avoiding duplicated zone numbers in the network. Entering the beginning zone number of this panel on highlighted position and pressing *ENTER*, the zone numbers of the FACP will start from this number. For example, if the beginning number is 003, then the FACP zone number will be 003, 004, 005....in sequence.

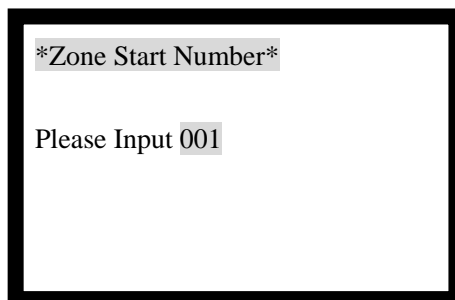

Fig. 6-46

#### 6.4.5 Customize

Entering number 5 in the screen in Fig. 6-37 will enter the customize screen, as shown in Fig. 6-47. In this screen you can setup the output mode and PAS delay time.

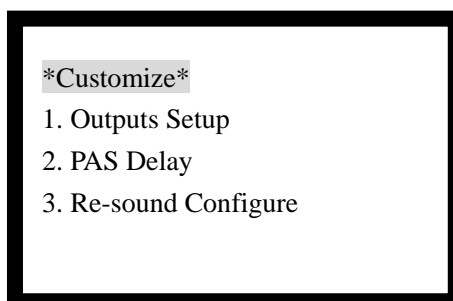
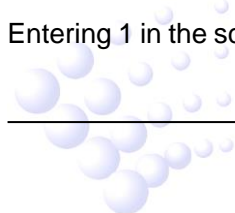

Fig. 6-47

##### 6.4.5.1 Output Setup

Entering 1 in the screen of Fig. 6-47 will enter the screen for setting up output modes, as



in Fig. 6-48.

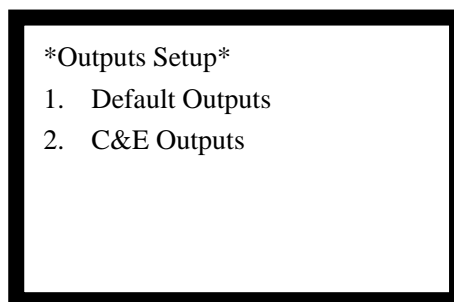

Fig. 6-48

#### 6.4.5.1.1 Default Outputs

Selecting “1. Default Outputs” in the screen of Fig. 6-48 will set SOUNDER CIRCUIT OUTPUT (Sounder A) on loop interface board and F.P.E. OUTPUT (F.P.E.) and the zonal sounder to default output. That is, if any fire alarm comes,

- If you have set the “Delay Mode” in Section 6.3.4.4 to “Disable”, Sounder A, zonal sounder and F.P.E. will be automatically started.
- If you have set the “Delay Mode” in Section 6.3.4.4 to “Enable”, Sounder A and zonal sounder output after a 30-second delay, and F.P.E. immediately outputs.

#### 6.4.5.1.2 C&E Outputs

Selecting “2. C&E Outputs” on the screen of Fig. 6-48 will set Sounder A on loop interface board and F.P.E. and the zonal sounder to output by C&E.

- The above Default Output does not take effect.
- Sounder A, zonal Sounder and F.P.E. need to be edited into C&E equation.
- Sounder A, zonal Sounder and F.P.E. are started according to C&E.

Note:

- 1 If you have set “Delay Mode” described in Section 6.3.4.4 to “Disable”, the delay time set here will not take effect.
- 2 Under no condition will F.P.E. output be delayed.

#### 6.4.5.2 PAS Delay Time Setup

Entering 2 in the screen of Fig. 6-47 will enter the screen for setting up PAS delay time, as in Fig. 6-49.

When the “PAS Mode” in Section 6.3.5.4 is set to “Enable”, the FACP will enter the first stage of delay on receiving a fire alarm. Pressing *ACK/MUTE* at this time, the FACP will enter the second stage of delay. The delay time for the second stage can be set in the screen shown in Fig. 6-49 as described in Section 6.3.5.4.

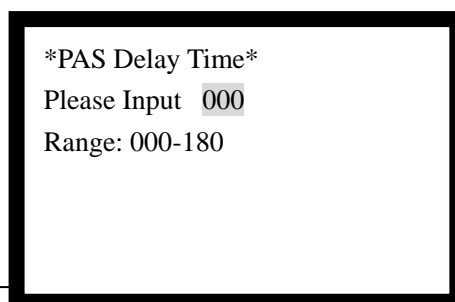

Fig. 6-49

### 6.4.5.3 Resounding Loop Sounders

Choosing “3” on the screen of Fig. 6-47 will enter the screen for resounding loop sounders, as in Fig. 6-50.

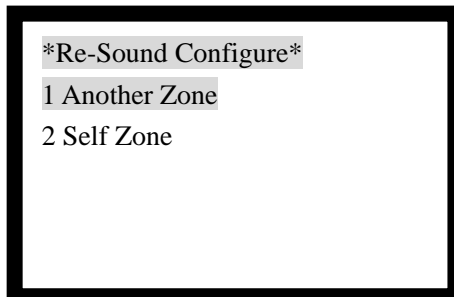

Fig. 6-50

#### 6.4.5.3.1 Resounding Sounders of Other Zones

Choosing “1” on the screen of Fig. 6-50, the silenced sounders of all zones will be resounded on a new fire alarm from any zone.

#### 6.4.5.3.2 Resounding Sounders of the Same Zone

Choosing “2” on the screen of Fig. 6-50, a new fire alarm will enable to resound sounders from the same zone. Sounders of other zones will not be resounded.

### 6.4.6 System Initialization

Entering “6” on the screen shown in Fig. 6-37 can initialize system data.

**Caution:**

**If the battery impedance monitoring is disabled, the panel will be non-compliant with the EN54-4 standard!**

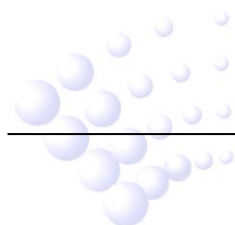

## Chapter 7 Standby Battery Calculations

Equation for calculating the battery capacity:

$$\text{Battery capacity ( Ah )} = I_{Q_{\max}} \times T_1 + (I_{Q_{\min}} + I_{L_{\max}} + I_{F_{\text{out}}}) \times T_2$$

In which:

$I_{Q_{\max}} = 0.75\text{A}$ , which is the quiescent current when the FACP is full-loaded;

$I_{Q_{\min}} = 0.42\text{A}$ , is the quiescent current when the FACP is with no load;

$I_{L_{\max}} = 0.3\text{A} \times 2 = 0.6\text{A}$ , is the maximum loop current for 2 detection loops;

$I_{F_{\text{out}}} = 0.5\text{A} \times 3 = 1.5\text{A}$ , which is the alarm output current (The FACP provides 3 fire alarm outputs, output current of each is 0.5A).

$T_1$  is the monitoring time when the FACP is full-loaded, which shall be at least 24 hours according to EN 54-4.

$T_2$  is the alarm time which shall be at least 30 minutes according to EN 54-4.

From the above equation, we can get the battery capacity is 19.26Ah, so that a 21Ah battery is recommended.

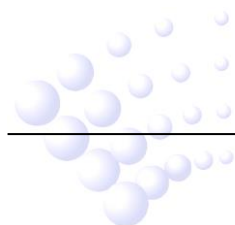

## Chapter 8 Maintenance

The FACP shall only be repaired by specially trained technical service personnel. Please disconnect the power before repair!

### 8.1 Replacing the Battery

Type of battery: Sealed lead-acid battery

Recommended period for replacing the battery: 5 years (25°C)

Recommended manufacturer and model: Power-Sonic PG12V21

Disposal of used batteries: Please properly dispose the used batteries according to your local rules and regulations.

#### NOTE:

- ✧ **RISK OF EXPLOSION IF BATTERY IS REPLACED BY AN INCORRECT TYPE.**
- ✧ **THERE IS NO BATTERY PROTECTION. REVERSE CONNECTION OF BATTERY WILL DAMAGE INTERNAL COMPONENTS OF FACP.**

### 8.2 Replacing the Fuses

Table 8-1

Location	Mark	Rated Value
Terminal Board F7.820.1857	F1	2A/250VAC, Time delay High breaking capacity ceramic tube fuse
Loop interface board F7.820. 828	F1, F2, F3	2A/250VAC, Fast Low breaking capacity glass tube fuse
Battery cables		5A/250VAC, Fast Low breaking capacity glass tube fuse

### 8.3 Troubleshooter

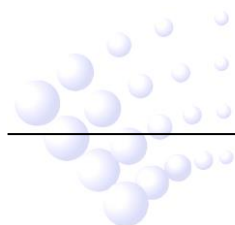



Table 8-2

No.	Problems	Possible Causes	Solutions
1	No indication on the panel or abnormal indication	a. AC input fuse blown b. AC-DC power supply is abnormal c. Loose connection with switchboard	a. Replace fuse b. Check and replace AC-DC power supply c. Check the connection to display board
2	Display "AC Fault" after power-up	a. No AC power b. AC fuse blown	a. Check and connect AC wire b. Replace AC fuse (refer to the specification on the label)
3	Display "Bat Fault" after power-up	a. Loose connection with battery b. Battery discharged or damaged	a. Check battery connection b. Power up for more than eight hours with the AC power supply, if the fault still exists, replace the batteries.
4	Unable to register loop equipment	Bus wrong or loose connection	Check the loop
5	Unable to register repeater panels	Wrong or loose connection of communication cables	Check power supply to repeaters and communication wires
6	Cannot print	a. Print mode is not set b. Loose connection with printer c. Printer damaged	a. Set the print mode b. Check printer connection c. Replace the printer
7	No response after pressing keys on zone indication and manual intervention panel	a. Loose connection with ZCP. b. The circuit board of ZCP damaged	a. Check ZCP connection, then re-register devices. b. Replace the circuit board of zone indication and manual intervention panel
8	Equipment fault	a. Equipment disconnected b. Equipment damaged	a. Check connection b. Replace equipment
9	Loop fault	Loop is shorted	Check the loop and repair
10	Clock or memory fault.	a. External interference b. Corresponding parts are	a. Check whether ground is properly connected

		aging.	b. Inform our technical service
--	--	--------	---------------------------------

### WEEE Information



2012/19/EU (WEEE directive): Products marked with this symbol cannot be disposed of as unsorted municipal waste in the European Union. For proper recycling, return this product to your local supplier upon the purchase of equivalent new equipment, or dispose of it at designated collection points.

## Appendix 1 Internal Connection Diagram

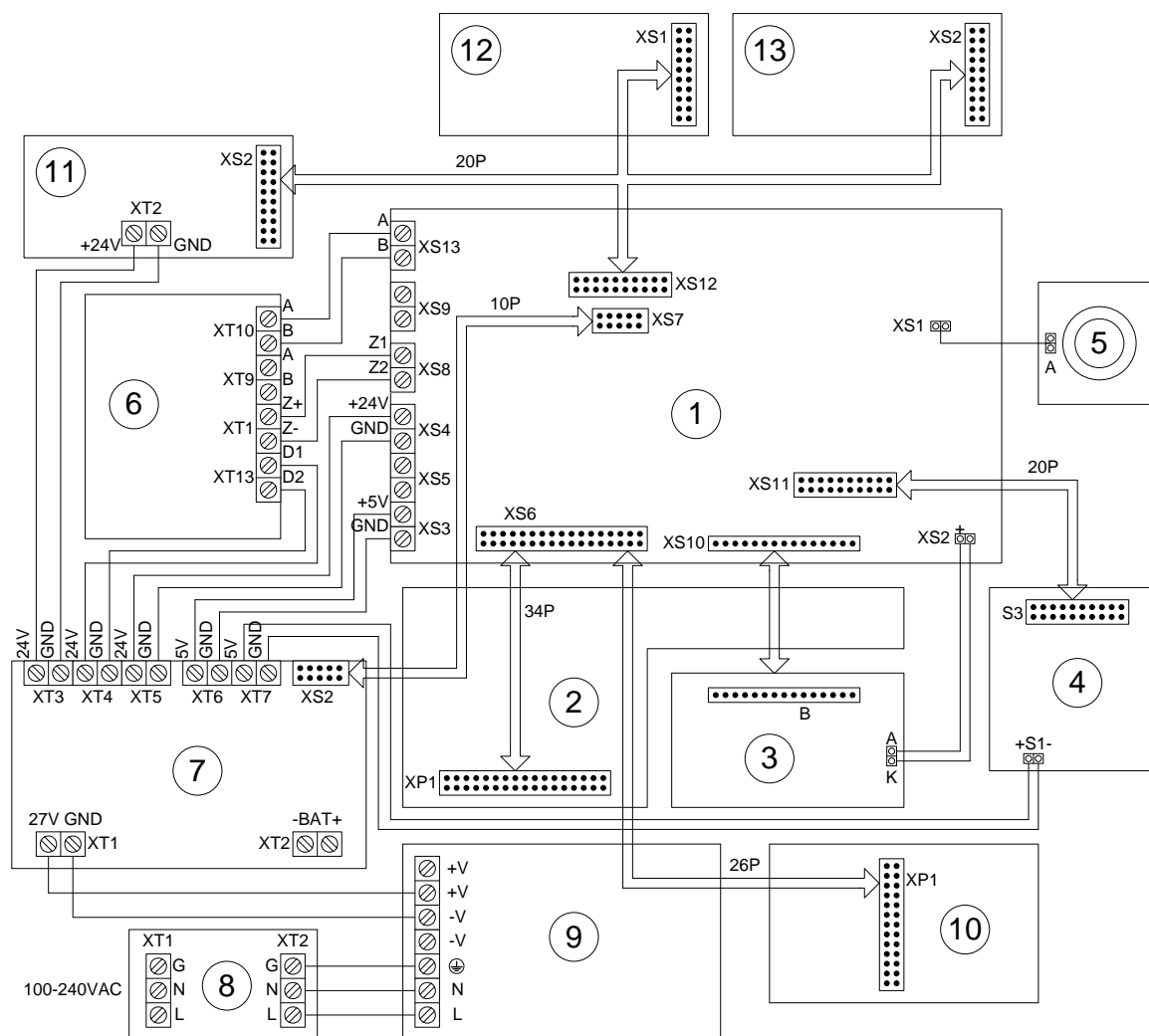

1 Main Board    2 Switch Board    3 LCD    4 Printer    5 Speaker

6 Loop Interface Board    7 Power Management Board    8 Terminal Board

9 AC-DC Switch Power Supply    10 Zone Control Panel (ZCP)    11 Loop Board

12 CAN Network Card (For future use)    13 CAN Network Card Loop Type

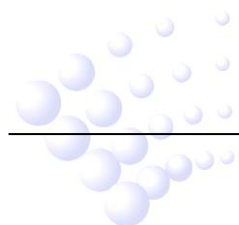

## Appendix 2 Internal Fault Description

No.	Problems	Description	Causes
1	AC Power	AC power fault	No AC power
2	Bat Fault	Battery fault	No battery or low voltage
3	BATHighZ	Battery high resistance	Battery aging or loose connection.
4	Charger	Charger fault	Charger circuit damaged.
5	Ground. F	Ground fault	Output loop connects to the ground.
6	F.P.E.	F.P.E. output loop fault	F.P.E. output circuit opens, shorts or the end-of-resistor is not connected.
7	Sounder A	Sounder output loop fault	Souder output loop opens, shorts or the end of line resistor is not connected.
8	Output1	Alarm output fault	Alarm output circuit opens, shorts or the end of line resistor is not connected.
9	PowerBox	Power box fault	Power damaged or can't communicate with main board.
10	Loop1FAIL	Class A Loop 1 fault	Class A loop 1 opens or shorts.
11	Loop2FAIL	Class A Loop 2 fault	Class A loop 2 opens or shorts.
12	Loop2 Card	Loop board 2 fault	Loop board 2 damaged or cannot communicate with main board.
13	Key Fault	Key fault	CPU for keys damaged or can't communicate with main board.
14	Access	ZCP fault	Zone indication panel damaged or cannot communicate with main board.
15	PortBoard	Loop interface board fault	The board damaged or cannot communicate with main board.
16	CRT Board	CRT board fault	CRT board damaged or cannot communicate with main board.
17	Net Card	Network card fault	The card damaged or can't communicate with main board.
18	Repeater	Panel repeater fault	The repeater damaged or can't communicate with main board.

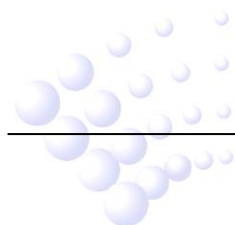

### Appendix 3 Device Type List

Noddefine	00	Undefined
MultiDet	01	Multi-sensor detector
Heat	02	Heat detector
Optical	03	Photoelectrical smoke detector
User Def	04	User defined device
Gas Det	05	Gas detector
Beam Det	06	Infrared beam detector
FlameDet	07	Ultraviolet flame detector
Con FACP	08	Cable heat detector
User Def	09	User defined device
Flow SW	10	Water flow indicator
MCP (BG)	11	Manual call point
SounderB	12	Fire broadcast
Sounder	13	Sounder strobe
Flasher	14	Flasher
Lift	15	Lift
Damper	16	Damper
FireDoor	17	Fire door
AHU	18	Air Conditioner
Extract	19	Smoker exhauster
BMS	20	Building management interface
VAModule	21	Voice alarm module
FTModule	22	Fire telephone
HR MCP	23	Hydrant call point
HR Pump	24	Hydrant pump
SPKR Pmp	25	Sprinkler pump
Elevator	26	Fire elevator
User Def	27	User defined device
User Def	28	User defined device
User Def	29	User defined device
User Def	30	User defined device
Trouble	31	Fault output
PSU	32	Power supply unit
User Def	33	User defined device
User Def	34	User defined device
User Def	35	User defined device
User Def	36	User defined device

User Def	37	User defined device
User Def	38	User defined device
Net Unit	39	Net unit
Repeater	40	Repeater panel
ZoneValv	41	Signal valve
Flow SW	42	Waterflow indicator
PS.DIFF	43	Foam pump
User Def	44	User defined device
User Def	45	User defined device
Gas Dump	46	Gas extinguisher start
GasAbort	47	Gas extinguisher stop
User Def	48	User defined device
User Def	49	User defined device
User Def	50	User defined device
User Def	51	User defined device
User Def	52	User defined device
Stop Mod	53	Device stop
Silence	54	Mute key
SounderA	55	Fire alarm sounder
SounderF	56	Fault sounder
Loop SW	57	Loop switch
CRTFault	58	GMC fault
Loop	59	Loop
PSU.Bat	60	Battery
PSU.AC	61	AC power
Lock	62	Control key
PART	63	Partial devices
ZoneDir	64	Zone indication
F.P.E.	65	Fire protection equipment

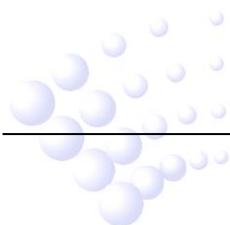

## Appendix 4 Operation Menu

### Menu

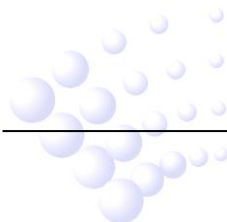
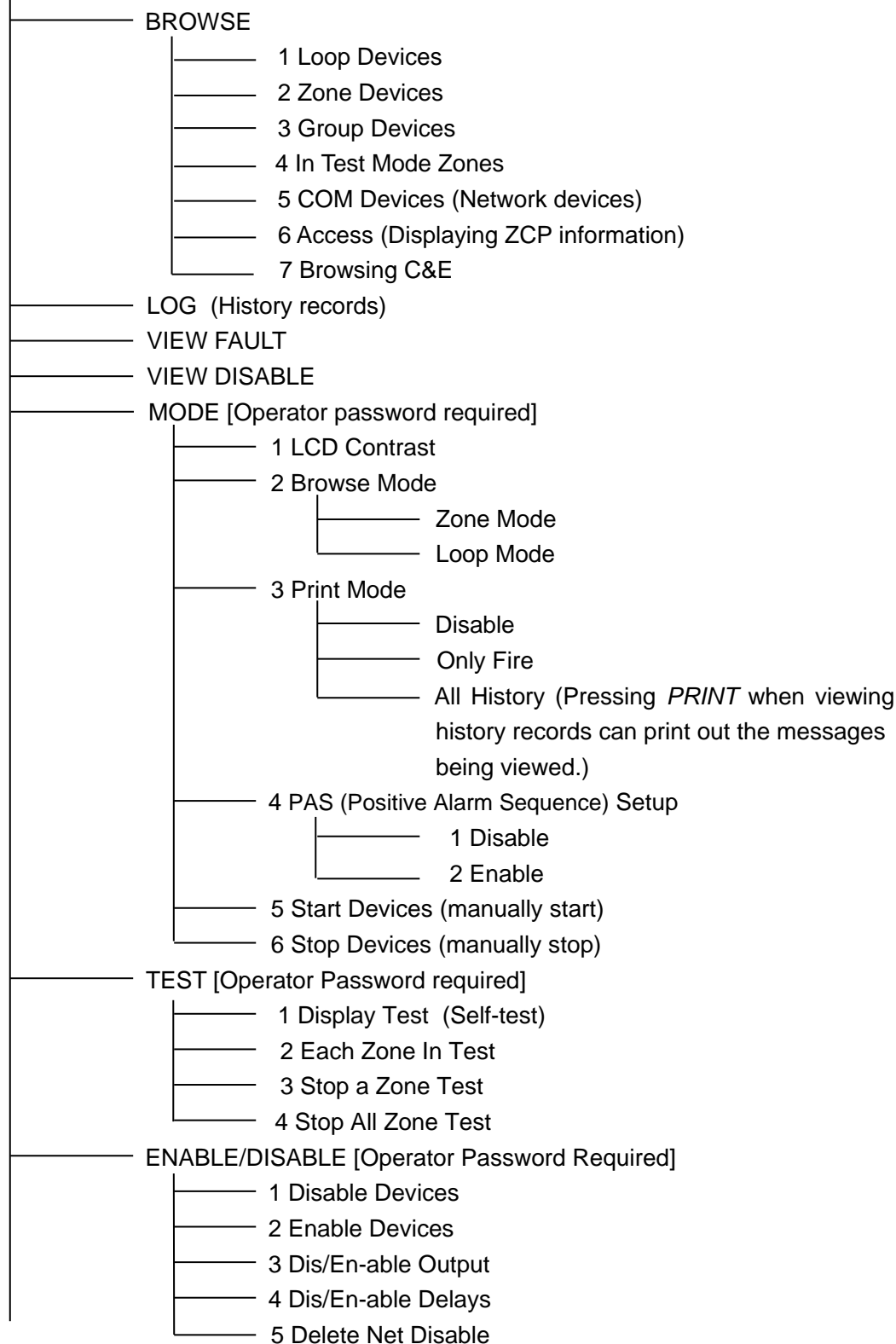

—	SYSTEM [Manager Password Required]
—	Time/Date
—	Password Change
—	Network Setup
—	Zone Start Number
—	Customize
—	Initialize System
—	Commission Service
—	ACK/MUTE (Silencing the FACP or acknowledging a fire alarm during the first stage of PAS delay)
—	SILENCE (Silencing all sounders in the system) [Operator Password Required]
—	EVAC (Start all sounder in the system for evacuation) [Operator Password Required]
—	LOCK (Locking keypad)
—	“ $\Delta$ ” / “ $\nabla$ ” (Turning pages)
—	ESC (Canceling or exiting operation menu, or enabling the FACP to displaying information of the highest priority)
—	ENTER (Confirmation an input. Shifting time display mode between month/day and hour/minute in normal standby state. )
—	RESET (Resetting the FACP from fire or fault to normal standby state) [Operator Password Required]

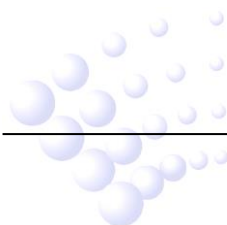



**Gulf Security Technology Co., Ltd.**

No. 80, Changjiang East Road, QETDZ, Qinhuangdao, Hebei,  
P. R. China 066004

Tel: +86 (0) 335 8502434

Fax: +86 (0) 335 8502532

[service.gst@fs.utc.com](mailto:service.gst@fs.utc.com)

[www.gst.com.cn](http://www.gst.com.cn)